

**YAESU**

# FT-8000R

## Dual-Band FM Mobile Transceiver

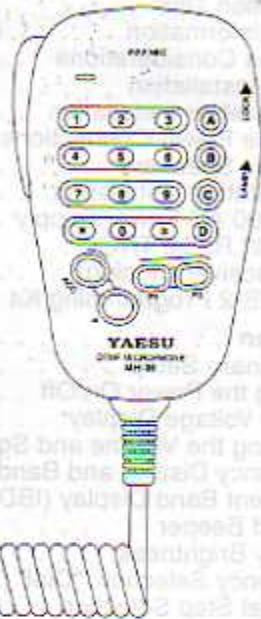

**INFORMATION ONLY**

## Table of Contents

<b>Specifications</b> . . . . .	<b>2</b>	VHF-VFH (V-V) or UHF-UHF (U-U) Operation	31
<b>Accessories &amp; Options</b> . . . . .	<b>3</b>	Sub Band Command Control . . . . .	31
<b>Front Panel Controls, Switches, &amp; Connector</b> . . . . .	<b>4</b>	Transmission . . . . .	32
<b>Rear Panel Connections</b> . . . . .	<b>10</b>	Power Output Setting . . . . .	32
<b>MH-36 Microphone &amp; Keypad</b> . . . . .	<b>12</b>	PTT Locking . . . . .	33
MH-42 <sub>BSJ</sub> Microphone & Keypad . . . . .	13	Repeater Splits . . . . .	33
<b>Installation</b> . . . . .	<b>14</b>	Memory Storage . . . . .	37
Preliminary Inspection . . . . .	14	Recalling Memories . . . . .	38
Installation Tips . . . . .	14	Alternating-Band Memory Selection (ABMS) . . . . .	39
Safety Information . . . . .	15	Home Channel Memories . . . . .	40
Antenna Considerations . . . . .	15	Memory Offset Tuning . . . . .	40
Mobile Installation . . . . .	17	Masking and Recovering Memories . . . . .	41
Transceiver Installation . . . . .	17	Scanning . . . . .	42
Mobile Power Connections . . . . .	18	Memory Skip Scanning . . . . .	43
Mobile Speakers . . . . .	18	Programmable Band-Scan Limits . . . . .	43
Base Station Installation . . . . .	19	Smart Search Operation . . . . .	45
FP-800 AC Power Supply . . . . .	19	Priority Channel Monitoring . . . . .	48
Packet Radio TNC . . . . .	19	CTCSS Operation . . . . .	49
Transceiver Cloning . . . . .	21	CTCSS Bell Paging with the FTS-22 . . . . .	51
ADMS-2 Programming Kit . . . . .	21	DTMF Autodialer Operation . . . . .	52
<b>Operation</b> . . . . .	<b>22</b>	Packet Operation . . . . .	54
Preliminary Setup . . . . .	22	Cross-Band Repeater Operation . . . . .	55
Turning the Power On/Off . . . . .	22	Time-Out Timer . . . . .	57
Supply Voltage Display . . . . .	22	Automatic Power Off (APO) . . . . .	57
Adjusting the Volume and Squelch . . . . .	23	<b>Appendix</b> . . . . .	<b>59</b>
Frequency Display and Band Change . . . . .	24	Power-On Settings . . . . .	59
Intelligent Band Display (IBD) . . . . .	26	In Case of Problems . . . . .	60
Keypad Beeper . . . . .	26	Resetting the CPU . . . . .	60
Display Brightness . . . . .	26	Memory Backup . . . . .	61
Frequency Selection: "Dial" (VFO) Mode . . . . .	27	<b>FTS-22 Installation</b> . . . . .	<b>62</b>
Channel Step Selection . . . . .	28	<b>Internal Adjustments</b> . . . . .	<b>63</b>
VFO Tracking . . . . .	28	LCD DC Voltmeter Alignment . . . . .	63
Receiver Muting . . . . .	28		
Monoband Operation . . . . .	30		

# FT-8000R Dual-Band FM Mobile Transceiver

The FT-8000R is a deluxe, compact FM mobile transceiver providing wide-band receive capability, along with a host of features which provide state-of-the-art performance on the 2-m and 70-cm amateur bands. Included in the FT-8000R's feature complement are:

- 50 Watts of power output on VHF, and 35 Watts on UHF, with High/Medium/Low selection on each band.
- Expanded receiver coverage: 110-550 MHz, and 750-1300 MHz (cellular telephone frequencies are blocked, and cannot be re-enabled).
- Outstanding packet radio capability at 1200 or 9600 bps with easy interface via a dedicated rear-panel jack.
- Dual Receive (VHF/UHF, VHF/VHF, or UHF/UHF) and Crossband Repeat capability is built in.
- 108 memory channels (54 per band) which store repeater shifts, odd repeater shifts, and CTCSS tones, plus one-touch HOME channels for each band.
- The Smart Search feature, which automatically sweeps a band and loads active frequencies into dedicated memory banks, is ideal for identifying active repeaters when visiting a city for the first time,

- Yaesu-exclusive Omni-Glow™ multi-function LCD display.

Additional features include a CTCSS encoder (FTS-22 CTCSS Decoder optional) providing 39 subaudible tones for repeater access, a transmit Time-Out-Timer (TOT), and separate speaker jacks for the VHF and UHF bands. And an all-new S-Meter Squelch circuit allows the owner to set the squelch to open at a programmable setting of the S-Meter, thus reducing guesswork in setting the squelch threshold.

Congratulations on your purchase of the FT-8000R! Whether this is your first rig, or if Yaesu equipment is already the backbone of your station, the Yaesu organization is committed to ensuring your enjoyment of this high-performance transceiver, which should provide you with many years of satisfying operation. Yaesu's dealer network and technical support personnel stand behind every product we sell, and we invite you to contact us should you require technical advice or assistance.

We recommend that you read this manual in its entirety prior to installing the FT-8000R, so that you fully understand the capabilities of your new transceiver fully.

# Specifications

## General

<b>Frequency Range:</b>	(RX) 110~550 MHz, 750~1300 MHz* (TX) 144-146 or 144-148 MHz 430-440 or 430-450 MHz *(Cellular frequencies are blocked)
<b>Channel Steps:</b>	5/10/12.5/15/20/25/50 kHz (VHF) 10/12.5/20/25/50 kHz (UHF)
<b>Frequency Stability:</b>	± 5 ppm (-5 °C ~ +50 °C)
<b>Repeater Shift:</b>	± 600 kHz (VHF) ± 1.6/5.0/7.6 MHz (UHF)
<b>Emission Types:</b>	F3 (G3E), F2 (1200 bps packet), F1 (9600 bps packet)
<b>Antenna Impedance:</b>	50 Ω, unbalanced
<b>Supply Voltage:</b>	DC 13.8 V ± 15%, negative ground
<b>Current Consumption:</b>	Receive; Less than 1.0 A Transmit; 11.5 A (VHF) 10.0 A (UHF)
<b>Operating temp.:</b>	-20 °C ~ +60 °C
<b>Case Size (WHD):</b>	140 x 40 x 152 mm (w/o knobs)
<b>Weight:</b>	Approx. 1.0 kg
<b>Transmitter</b>	
<b>RF Power Output:</b>	50/10/5 Watts (VHF) 35/10/5 Watts (UHF)

<b>Modulation Type:</b>	Variable Reactance
<b>Maximum Deviation:</b>	± 5 kHz
<b>Spurious Emissions:</b>	> 60 dB below carrier
<b>Mic. Impedance:</b>	600 - 10 kΩ

## Receiver

<b>Circuit Type:</b>	Double-conversion Superheterodyne
<b>Intermediate Frequencies:</b>	45.05 MHz & 455 kHz (VHF) 58.525 MHz & 455 kHz (UHF)
<b>Sensitivity (12 dB SINAD):</b>	< 0.18 μV (Main Receiver) < 0.25 μV (Sub Receiver)
<b>Selectivity :</b>	12 kHz (-6 dB)/24 kHz (-60 dB)
<b>Image Rejection:</b>	Better than 70 dB
<b>Squelch Sensitivity:</b>	Better than 0.13 μV
<b>AF Output:</b>	2 Watts @ 8 Ω for 5% Total Harmonic Distortion
<b>AF Output Imp.:</b>	4 - 16 Ω (Internal Speaker: 8 Ω)

*Specifications subject to change without notice or obligation. Specifications guaranteed only within the amateur bands. Frequency range and repeater shift may vary according to local requirements and regulations.*

Downloaded by  
RadioAmateur.EU

# Accessories & Options

## Accessories Supplied with FT-8000R

- Microphone (see list below)
- MMB-36 Mobile Mounting Bracket
- DC Power Cord w/Fuse (Part #T9015605)
- Spare 15 A Fuse

## Available Options for your FT-8000R

- ADMS-2C Programming Kit with Software
- AD-3 VHF/UHF Diplexer for Two-Antenna Operation
- CT-39 Packet Cable
- FP-800 AC Power Supply with Loudspeaker
- FTS-22 Tone Squelch Unit
- MEK-2 Microphone Extension Kit
- MH-36<sub>B6J</sub> Hand Microphone w/DTMF Keypad
- MH-42<sub>B6J</sub> Hand Microphone w/1750 Hz Burst Button
- MMB-60 Quick-Release Mobile Bracket
- SP-7 External Loudspeaker
- YH-1/SB-10 Headset with PTT Switch Unit

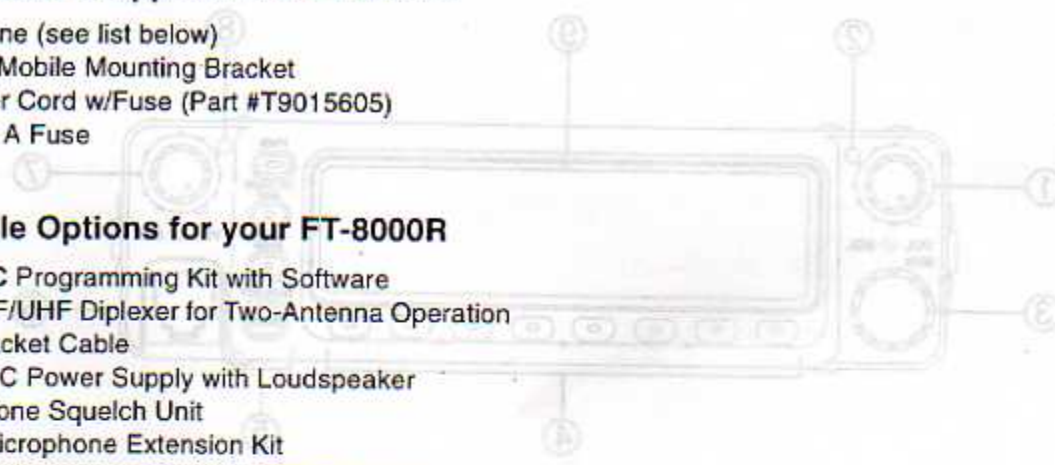

*Availability of accessories may vary. Some accessories are supplied as standard per local requirements, while others may be unavailable in some regions. Consult your Yaesu dealer for details regarding these and any newly-available options. Connection of any non-Yaesu-approved accessory, should it cause damage, may void the Limited Warranty on this apparatus.*

# Front Panel Controls, Switches, and Connector

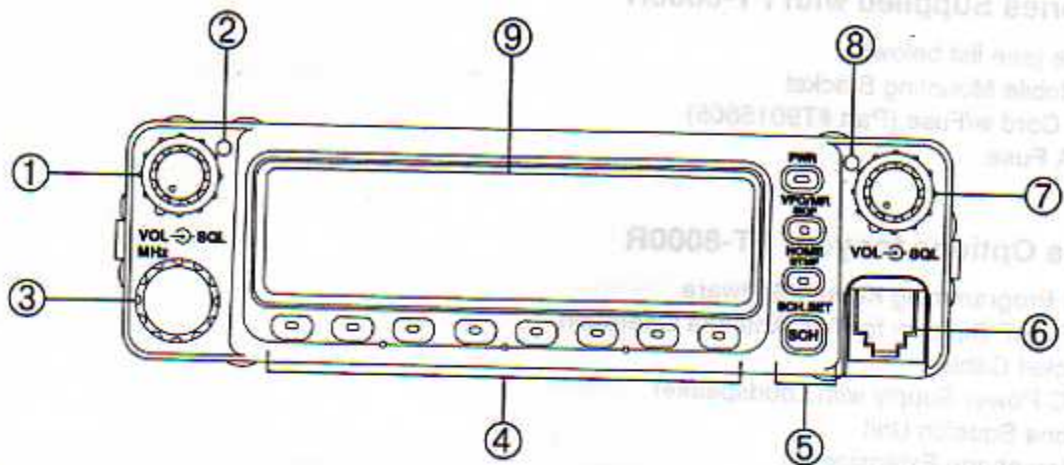

## ① VOL/SQL (Left)

The inner Volume control adjusts the speaker audio level from the "left" (normally, VHF) receiver. Clockwise rotation increases the audio level. This control does not affect the level of audio presented to the rear panel **DATA** jack.

The outer Squelch control is used to silence background noise on the "left" receiver. It should be advanced clockwise just to the point where the noise is silenced (and the "BUSY" indicator on the display turns off), so as to provide the best sensitivity to weak signals.

## ② Left TX/RX LED

This dual-color LED glows Green when operating command is assigned to the left (VHF) channel, and it blinks during Intelligent Band Display operation when a signal is being received on the left channel. The LED glows Red when you are transmitting using the left channel.

## ③ Main Dial/MHz

This 20-position detented rotary switch is the main tuning dial for the transceiver. It is used for most

tuning, memory selection, and function setting functions on the FT-8000R.

When this control is pushed in momentarily during VFO operation, the transceiver then tunes in 1 MHz steps, and if pushed and held in for  $\frac{1}{2}$  second, the transceiver tunes in 10 MHz steps, thus allowing quick frequency change.

#### ④ Function Keys

These eight keys select many of the most important operating features on the FT-8000R. The function of the key is indicated along the bottom edge of the display.

If the [F/W] key is pressed (momentarily) *before* one of these keys is pressed, the "Alternate" functions of these keys will be enabled; these functions are displayed in a row *immediately above* the main function indicators along the bottom edge of the display.

If the [F/W] key is *pressed and held in for  $\frac{1}{2}$  second* prior to pressing another front panel key, the "Super-Alternate" function of the latter key will be activated. These functions will be displayed as icons elsewhere in the LCD.

These command keys include:

#### [F/W]

This key is used to activate the "Alternate" or "Super-Alternate" command functions of the panel keys, as well as for memory storage.

#### [REV](STEP)

The normal function of this key is for reversing the transmit and receive frequencies when a repeater split is programmed.

The alternate function of this key is used for setting the synthesizer step size during VFO operation.

The super-alternate function of this key is used to "Mask" a memory channel that temporarily is not needed for operation (but which you might need later)

#### [RPT](R.SET)

The normal function of this key is used for activating repeater shift (either +, -, or simplex).

The alternate function of this key is used for setting a different default repeater shift, if desired.

There is no super-alternate function for this key.

#### [TONE](T.SET)

The normal function of this key is used for activating the CTCSS mode of operation: **ENC**ode, **DE**-Code, or CTCSS Off (optional FTS-22 required for Decode operation).

The alternate function of this key is used for choosing the desired CTCSS tone frequency.

The super-alternate function of this key is used to select the Packet baud rate to be used (1200 or 9600 bps).

#### [MUTE](M.SET)

The normal function of this key is to activate the receiver Mute function.

The alternate function of this key is used to set the *duration* of muting of the receiver; the default is one minute.

The super-alternate function of this key is used to activate or deactivate the Time-Out Timer (TOT) feature.

#### [CNTL](VV/UU)

The normal function of this key is used to allow the operator to make changes to the "Sub" band without affecting the operating status on the "Main" band.

The alternate function of this key is used to activate VHF-VHF or UHF-UHF operation, as opposed to "normal" VHF-UHF operation.

The super-alternate function of this key is used to toggle the Intelligent Band Display (IBD) feature on and off.

#### [LOW](LOCK)

The normal function of this key is used to set the transmitter power output level: Low, Medium, or High.

The alternate function of this key is used to activate the front panel Key Lockout feature.

The super-alternate function of this key is used to activate the PTT (transmission) Lockout feature.

#### [SCAN](S.SET)

The normal function of this key is used to activate scanning.

The alternate function of this key is used to set the desired Scan-Resume mode, either Carrier-Drop or 5-Second Restart.

There is no super-alternate function for this key.

### ⑤ Command Keys

These four keys operate in a manner similar to the Function keys just described, except that they have no icons in their immediate vicinity to indicate the action taken by pushing them (the indication, if any, appears elsewhere on the LCD). These keys include:

#### [PWR]

This is the main On/Off switch for the FT-8000R.

#### [VFO/MR](SKIP)

The normal function of this key is to allow the



operator to toggle between VFO (Dial) and MR (Memory Recall) operation.

The alternate function of this key is to designate memory channels to be skipped during scanning. The super-alternate function of this key is used during the programming of DTMF Autodial Memories.

#### **[HOME](DTMF)**

The normal function of this key is used as a one-touch memory recall key for a favorite frequency.

The alternate function of this key is used to activate the CTCSS Bell Alarm feature.

The super-alternate function of this key is used to store the HOME channel into memory.

#### **[SCH](SCH.SET)**

The normal function of this key is used to activate the Smart Search feature.

The alternate function of this key is used to set the Smart Search operating mode, either Continuous sweeping or One-Shot sweeping of the band.

The super-alternate function of this key is used to activate the "S-Meter Squelch" feature.

#### **⑥ Microphone Jack**

This 6-pin modular jack accepts transmit audio, band selection, and scanning control commands from the microphone, and provides speaker audio for a speaker/microphone or data TNC.

#### **⑦ VOL/SQL (Right)**

The inner Volume control adjusts the speaker audio level from the "right" (normally, UHF) receiver. Clockwise rotation increases the audio level. This control does not affect the level of audio presented to the rear panel DATA jack.

The outer Squelch control is used to silence background noise on the "right" receiver. It should be advanced clockwise just to the point where the noise is silenced (and the "BUSY" indicator on the display turns off), so as to provide the best sensitivity to weak signals.

#### **⑧ Right TX/RX LED**

This dual-color LED glows Green when operating command is assigned to the right (UHF) channel, and it blinks during Intelligent Band Display operation when a signal is being received on the right channel. The LED glows Red when you are transmitting using the right channel.

#### **⑨ Liquid Crystal Display**

The Liquid Crystal Display (LCD) for the FT-8000R features Yaesu's exclusive Omni-Glow™ illumination, which provides high readability under a wide variety of ambient lighting conditions, as well as minimal degradation of "night vision" during evening mobile operation.

The upper section of the LCD is divided into two

main frequency display areas: the left side is the "VHF" area, while the right side is the "UHF" area. Frequency, tone signaling, and memory information for each side may be viewed independently,

and the "▲" icon indicates which register (VHF or UHF) is the "Main" band on which transmission is permitted. See the "Operation" chapter for more details.

### LCD Indicators

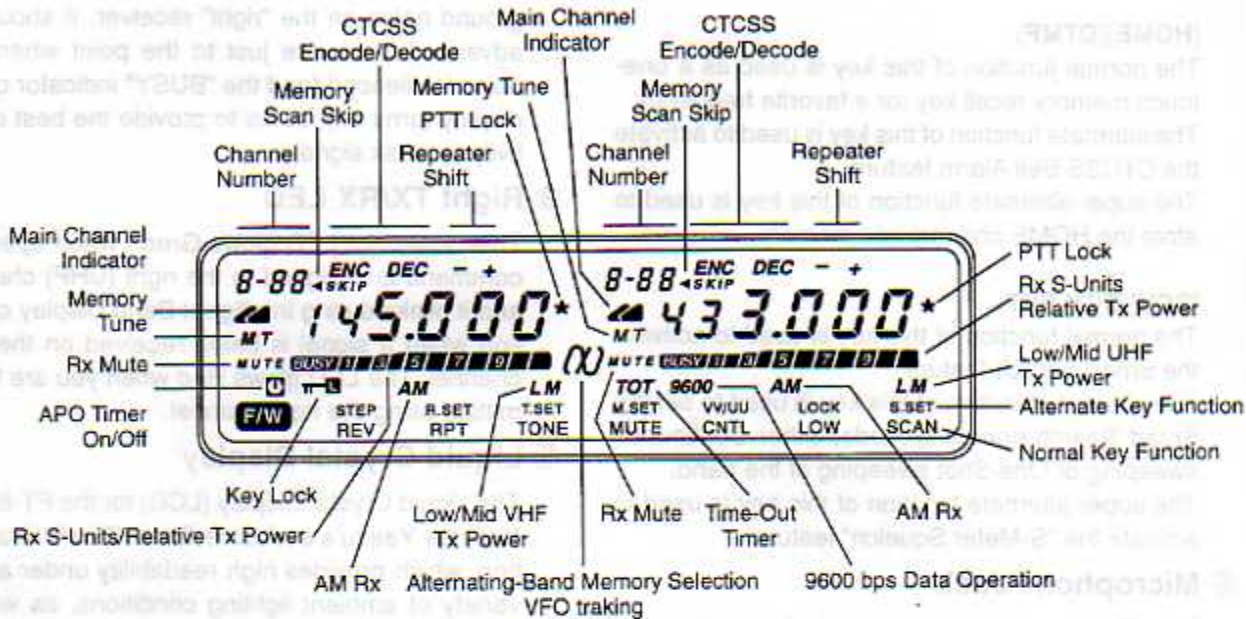

# Rear Panel Connections

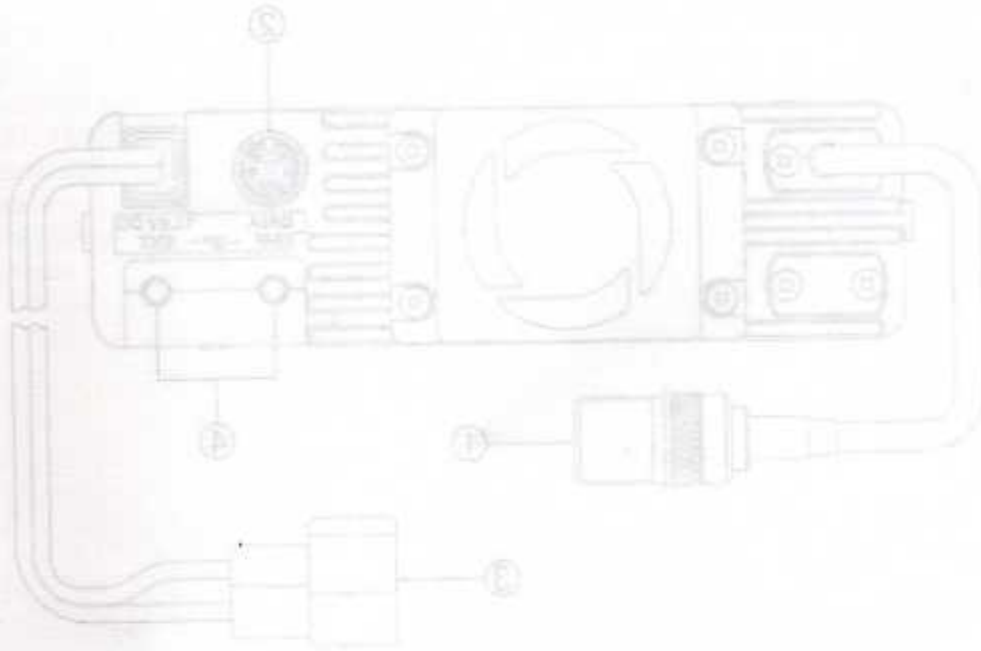

## 1) Antenna Cable Pigtail

Connect a dual-braid antenna's 50 Ω cable to this M-Type (SO-238) coaxial connector. European versions are equipped with a Type-N connector. Be certain to use the proper type of plug for connection of the antenna cable.

## 2) DATA Jack

This 6-pin mini-DIN connector provides simple interfacing to a packet Terminal Node Controller (TNC) for 1200 baud or 9600 baud operation, as well as for channel programming using a personal computer and Yesu's GEMS-2 Programming Kit.

## Rear Panel Connections

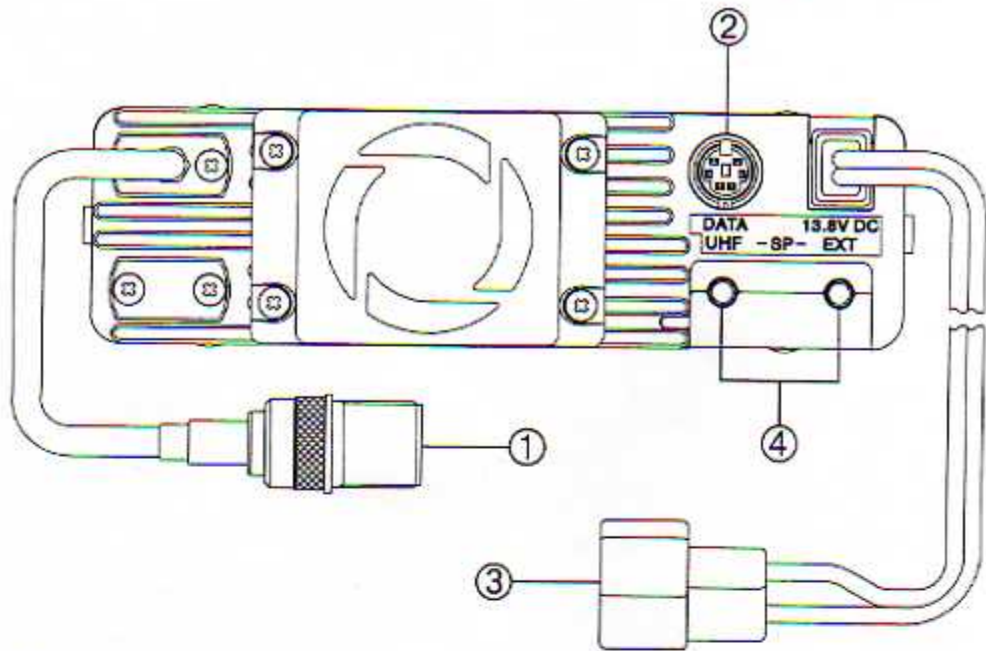

## ① Antenna Cable Pigtail

Connect a dual-band antenna's 50  $\Omega$  cable to this M-type (SO-239) coaxial connector. European versions are equipped with a Type-N connector. Be certain to use the proper type of plug for connection of the coaxial cable.

## ② DATA Jack

This 6-pin mini-DIN connector provides simple interfacing to a packet Terminal Node Controller (TNC) for 1200 bps or 9600 bps operation, as well as for channel programming using a personal computer and Yaesu's ADMS-2 Programming Kit.

### ③ 13.8V DC Cable Pigtail w/Fuse

This is the DC power supply connection for the transceiver. Use the supplied DC cable to connect this pigtail to the car battery or base station DC power supply capable of at least 12 Amperes (continuous duty). Make certain that the **Red** lead connects to the **Positive** side of the power source, and that the **Black** lead connects to the **Negative** side of the power source. See the Installation chapter for more details.

### ④ SP (Speaker) Jacks (UHF & EXT)

These 2-conductor, 3.5 mm mini phone jacks provide separate VHF and UHF audio outputs for an optional speaker. The optimum load impedance is 8 Ω. Inserting a plug into the **UHF** jack disables UHF audio from the transceiver's *internal* speaker. Both VHF and UHF audio from the internal speaker is disabled with a plug is inserted into the **EXT** jack.



PTT

Press this switch to transmit, and release it to receive.

DTMF LED

The LED glows Red when the DTMF keys are pressed to confirm closure of the key contacts (no DTMF monitor tone will be heard).

## MH-36 Microphone & Keypad

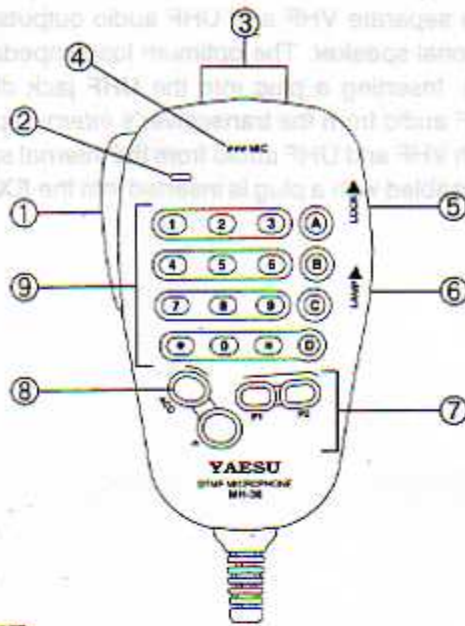

**① PTT**

Press this switch to transmit, and release it to receive.

**② DTMF LED**

This LED glows Red when the DTMF keys are pressed, to confirm closure of the key contacts (no DTMF monitor tone will be heard).

**③ [UP]/[DWN]**

Press or hold in either of these keys to tune or scan up or down the band or through the memory channels. In many ways, these keys emulate the function of the (rotary) Main Dial. See the "Operation" chapter for details.

**④ MIC**

Inside this grill is the condenser microphone element. Speak across this microphone opening in a normal tone of voice, while pressing the PTT switch, to transmit.

**⑤ LOCK ►**

This switch locks out the MH-36 controls and keys.

**⑥ LAMP ►**

This switch turns on the keypad back-light, for easier viewing at night.

**⑦ [P]/[P1]/[P2]**

These keys have no function when using the FT-8000R.

**Downloaded by  
RadioAmateur.EU**

### ⑧ [ACC]

The **ACC** key, as enabled on the FT-8000R, is used for

- (A) Band change (VHF to UHF, and vice versa) on most versions; or
- (B) Tone Call (1750 Hz) on European versions.

### ⑨ [0] ~ [9], [\*], and [A] ~ [D] Keys

These keys generate DTMF tones during transmission.

**Note:** DTMF keys may not be available on some transceiver versions. Microphone appearance may differ slightly from that shown in drawing.

## MH-42<sub>B6J</sub> Microphone & Keypad

The MH-42<sub>B6J</sub> is similar to the MH-36<sub>B6J</sub>, but the MH-42<sub>B6J</sub> does not include a DTMF keypad.



This chapter describes the installation procedure for integrating the FT-8000R into a typical amateur radio station. It is presumed that you possess technical knowledge and conceptual understanding consistent with your status as a licensed radio amateur. Please take some extra time to make certain that the important safety and technical requirements detailed in this chapter are followed closely.

### ***Preliminary Inspection***

Inspect the transceiver visually immediately upon opening the packing carton. Confirm that all controls and switches work freely, and inspect the cabinet for any damage. Gently shake the transceiver to verify that no internal components have been shaken loose due to rough handling during shipping.

If any evidence of damage is discovered, document it thoroughly and contact the shipping company (or your local dealer, if the unit was purchased over-the-counter) so as to get instructions regarding the prompt resolution of the damage situation. Be certain to save the shipping carton, especially if there are any punctures or other evidence of damage incurred during shipping; if it is necessary to return the unit for service or replacement, use the original packing materials but put the entire package inside another

## **Installation**

packing carton, so as to preserve the evidence of shipping damage for insurance purposes.

If you have purchased the optional FTS-22 Tone Squelch Unit, install it now, as described on page 62. Then proceed with other aspects of your installation work.

### ***Installation Tips***

To ensure long life of the components, be certain to provide adequate ventilation around the cabinet of the FT-8000R. The cooling system of the transceiver must be free to draw cool air in through the ventilation holes and expel warm air from the rear of the transceiver.

Do not install the transceiver on top of another heat-generating device (such as a power supply or amplifier), and do not place equipment, books, or papers on top of the FT-8000R. Place the transceiver on a hard, flat, stable surface. Avoid heating vents and window locations that could expose the transceiver to excessive direct sunlight, especially in hot climates. The FT-8000R should not be used in an environment where the ambient temperature exceeds +60 °C (140 °F).



## Safety Information

The FT-8000R is an electrical apparatus, as well as a generator of RF (Radio Frequency) energy, and you should exercise all safety precautions as are appropriate for this type of device. These safety tips apply to any device installed in a well-designed amateur radio station.

- Do not allow unsupervised children to play in the vicinity of your transceiver or antenna installation.
- Be certain to wrap any wire or cable splices thoroughly with insulating electrical tape, to prevent short circuits.
- Do not route cables or wires through door jams or other locations where, through wear and tear, they may become frayed and shorted to ground or to each other.
- Do not stand in front of a directional antenna while you are transmitting into that antenna, especially on UHF. Do not install a directional antenna in any location where humans or pets may be walking in the main directional lobe of the antenna's radiation pattern.
- In mobile installations, it is preferable to mount your antenna on top of the roof of the vehicle, if feasible, so as to utilize the car body as a counterpoise for the antenna and raise the radiation pattern as far away from passengers as possible.

- During vehicular operation when stopped (in a parking lot, for example), make it a practice to switch to Low power if there are people walking nearby.
- Never wear dual-earmuff headphones while driving a vehicle.

## Antenna Considerations

The FT-8000R is designed for use with antennas presenting an impedance of near 50  $\Omega$  at all operating frequencies. The antenna (or a 50  $\Omega$  dummy load) should be connected whenever the transceiver is turned on, to avoid damage that could otherwise result if transmission occurs accidentally without an antenna.

Ensure that your antenna is designed to handle 50 Watts of transmitter power. Some magnetic-mount mobile antennas, designed for use with hand-held transceivers, may not be capable of this power level. Consult the antenna manufacturer's specification sheet for details.

Most all FM work is performed using vertical polarization. When installing a directional antenna such as a Yagi or Quad, be certain to orient it so as to produce vertical polarization, unless you are engaged in a special operating situation where horizontal polarization is used.

Note that this transceiver is designed with wide frequency coverage. For best receiver performance, be certain that your antenna is at *least* designed for so-called "Dual Band" (2m and 70cm) operation. For general listening, you may wish to have a broadband antenna such as a discone available.

Excellent reference texts and computer software are available for the design and optimization of VHF and UHF antennas. Your dealer should be able to assist you with all aspects of your antenna installation requirements.

Use high-quality 50  $\Omega$  coaxial cable for the lead-in to your FT-8000R transceiver. All efforts at providing an efficient antenna system will be wasted if poor quality, loose coaxial cable is used. Losses in coaxial lines increase as the frequency increases, so an 8-meter-long (25') coaxial line with 0.5 dB of loss at 28 MHz may have a loss of 2 dB or more at 440 MHz; choose your coaxial cable carefully based on the installation location (mobile vs. base) and the overall length of the cable required (for very short runs of cable in a mobile installation, the smaller, more flexible cable types may be acceptable).

For reference, the chart below shows approximate loss figures for typically-available coaxial cables frequently used in VHF/UHF installations.

**Loss in dB per 30m (100 feet) for Selected 50 $\Omega$  Coaxial Cables (Assumes 50 $\Omega$  Input/Output Termination's)**

Cable Type	Loss: 144 MHz	Loss: 440 MHz	Loss: 1 GHz
RG- 58A	6.5	13	>20
RG- 58Foam	4.7	8.5	13
RG-8A, RG-213	3.0	5.7	9.2
RG-8 Foam	2.0	3.7	5.5
Belden®9913	1.5	2.7	4.3
1/2" "Hardline"	1.0	1.8	3.0
7/8" "Hardline"	0.7	1.3	2.3

Loss figures are approximate; consult cable manufacturers' catalogs for complete specifications.

In outdoor installations, be certain to weatherproof all connectors thoroughly, as water entering a coaxial cable will cause losses to escalate rapidly, thus diminishing your communications effectiveness. The use of the shortest possible length of the highest quality coaxial cable that fits within your budget will ensure the best performance from your FT- 8000R.

## Mobile Installation

The FT-8000R must only be installed in vehicles having a **negative ground** electrical system. Mount the transceiver where the display, controls, and microphone are easily accessible, using the supplied MMB-36 mounting bracket. The transceiver may be installed in any position, but should not be positioned near a heating vent nor anywhere where it might interfere with driving (either visually or mechanically). Make sure to provide plenty of space (A) at the rear of the transceiver so that air can flow freely through the heatsink, and (B) underneath so as to allow sound from the internal speaker to be heard. Refer to the diagrams showing proper installation procedures.

### Transceiver Installation

- Choose a mounting location with sufficient clearance for the transceiver, plus space for ventilation around the cooling fan and above and below the radio. Using the mounting bracket as a template for the mounting holes, use a 4.8 mm (3/16") bit to drill the mounting holes, and secure the mounting bracket with the supplied screws, washers, and nuts (see diagram).
- Position the transceiver in the bracket so that the holes in the side are aligned with those in the bracket, and bolt the transceiver into place using the supplied short screws and flat washers.

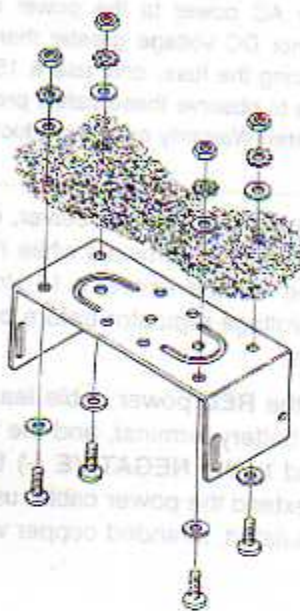

*Mobile Power Connections*

To minimize voltage drop and avoid blowing the vehicle's fuses, connect the supplied DC power cable directly to the battery terminals. *Do not attempt to defeat or bypass the DC cable's fuse — it is there to protect you, your transceiver, and your vehicle's electrical system.*

**Warning!**

Never apply AC power to the power cable of the FT-8000R, nor DC voltage greater than 15.2 Volts. When replacing the fuse, only use a 15-A fast-blow type. Failure to observe these safety precautions will void the Limited Warranty on this product.

- Before connecting the transceiver, check the voltage at the battery terminals while revving the engine. If the voltage exceeds 15 Volts, adjust the vehicle's voltage regulator before proceeding with installation.
- Connect the **RED** power cable lead to the **POSITIVE (+)** battery terminal, and the **BLACK** power cable lead to the **NEGATIVE (-)** terminal. If you need to extend the power cable, use #14 AWG or larger insulated, stranded copper wire. Solder the

splice connections carefully, and wrap the connections thoroughly with insulating electrical tape.

- Before connecting the cable to the transceiver, verify the voltage and polarity of the voltage *at the transceiver end of the DC cable* using a DC voltmeter. Now connect the transceiver to the DC cable.

*Mobile Speakers*

The optional SP-7 External Speaker includes its own swivel-type mounting bracket, and is available from your Yaesu dealer.

For greater ease in separating VHF audio from UHF audio, two speakers may be connected to the rear panel **SP** jacks. The following guidelines apply for connections to these jacks:

- Inserting a speaker plug into the **UHF SP** jack routes UHF audio to the external speaker, while VHF audio remains on the internal speaker.
- Inserting a speaker plug into the **EXT SP** jack causes both Main and Sub channel audio to be routed to the external speaker.
- Inserting speaker plugs into both **SP** jacks routes UHF audio to one speaker, and VHF audio to the other speaker.

## Base Station Installation

The FT-8000R is ideal for base station use as well as in mobile installations. The FT-8000R is specifically designed to integrate into your station easily, using the information to follow as a reference.

### FP-800 AC Power Supply

Operation of the FT-8000R from an AC line **requires** a power source capable of providing at least 12 Amps continuously at 13.8 Volts DC. The FP-800 AC Power Supply/Loudspeaker is available from your Yaesu dealer to satisfy these requirements. Other well-regulated power supplies may be used, as well, if they meet the above voltage and current specifications.

Use the DC power cable supplied with your transceiver for making power connections to the power supply. Connect the **RED** power cable lead to the **POSITIVE (+)** power supply terminal, and connect the **BLACK** power cable lead to the **NEGATIVE (-)** power supply terminal.

The speaker plug from the FP-800 may be connected to the **EXT SP** jack on the rear panel of the FT-8000R, if desired.

### Packet Radio Terminal Node Controller (TNC)

The FT-8000R provides a convenient rear-panel **DATA** jack for easy connections to your TNC. The connections to this jack are in accordance with a standard adopted by many amateur-product manufacturers. However, we recommend that you verify the connections to any cable you already own by comparison to the pictorial below.

Only the "Main" band may be used for packet operation, as there are no connections to the "Sub" band via the **DATA** jack (since transmission is not possible on the "Sub" band).

The FT-8000R's **DATA** jack connections are optimized for the data transmission and reception speed in use. In accordance with industry standards, the signal levels, impedances, and bandwidths are significantly different on 9600 bps as opposed to 1200 bps. If your TNC does not provide multiple lines to accommodate such optimization, you may still be able to utilize your TNC, if it is designed for multiple-radio use, by connecting the TNC "Radio 1" port to the 1200 bps lines on the FT-8000R, and the "Radio 2" port to the 9600 bps lines.

For ease in making connections to your TNC, the optional CT-39 Packet Cable for the FT-8000R is available from your Yaesu dealer. With reference to the "**Data Jack Pin Connections**" chart and data jack pinout pictorial on next page, you may connect

your TNC in minutes using the color code information provided.

Data Jack Pin Connections			
Pin	Label	CT-39 Wire Color	Notes
1	PKD	Orange	Packet Data Input: Impedance: 10 k $\Omega$ Max. Input Level: 40 mV pp @ 1200 bps 2.0 V pp @ 9600 bps
2	GND	Yellow	Signal Ground
3	PKS	Red	Ground to Transmit
4	RX9600	Green	9600 bps Packet Data Output: Impedance: 10 k $\Omega$ Max. Output: 500 mV pp
5	RX1200	Violet	1200 bps Packet Data Output: Impedance: 10 k $\Omega$ Max Output: 300mV pp
6	SQL	Black	Squelch Control: Squelch Open: +5V Squelch Closed: 0V

Station Interconnections for Digital Modes

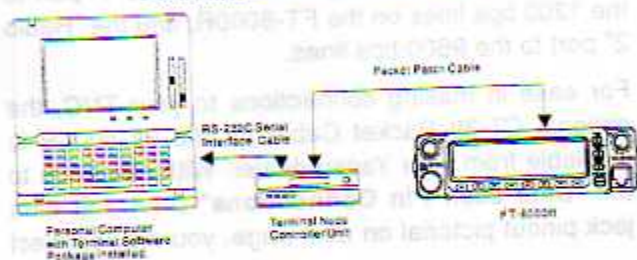

Most modern TNCs use A PLL-type DCD (Data Carrier Detect) circuit, so you will generally not need to connect anything to the Squelch Control line (Pin 6) of the DATA jack.

Note that 9600 bps packet transmit-deviation adjustment is very critical to successful operation, and can only be accomplished using a calibrated deviation meter (such as that found on an FM Service Monitor used in a communications service center). In most cases, the Packet Data Input level (set via a potentiometer inside the TNC) must be adjusted to provide a deviation of  $\pm 2.75$  kHz ( $\pm 0.25$  kHz). Check with your packet node's sysop if you have any questions about the appropriate deviation level for your network.

The setting of the 1200 bps Packet Data Input level is much less critical, and satisfactory adjustment to the optimum ( $\pm 2.5$  -  $\pm 3.5$  kHz) deviation can usually be done "by ear" by adjusting the TNC's 1200 bps TX Audio Level potentiometer so that the outgoing packets (as monitored on a separate VHF or UHF receiver) are approximately the same level as (A) the DTMF tones produced by the MH-36<sub>85J</sub> microphone, or (B) the 1750 Hz Burst tone produced by the MH-42<sub>85J</sub> microphone, if your transceiver is equipped with one of these microphones.



(as viewed from the rear panel)

## Transceiver Cloning

You can transfer all data stored in one FT-8000R to another set by utilizing the handy "Cloning" feature. This requires a user-constructed Cloning Cable which connects the **DATA** jacks on the two transceivers as shown below. To clone from one transceiver to another, use the following procedure:

- Insert the Clone Cable into the **DATA** jack of each transceiver.
- Turn both transceivers off, then press and hold in the **[FW]** key on each radio while turning the power on again. All segments on the display will start blinking.
- On the "target" radio, press the **[REV]** key. The display will stop blinking.

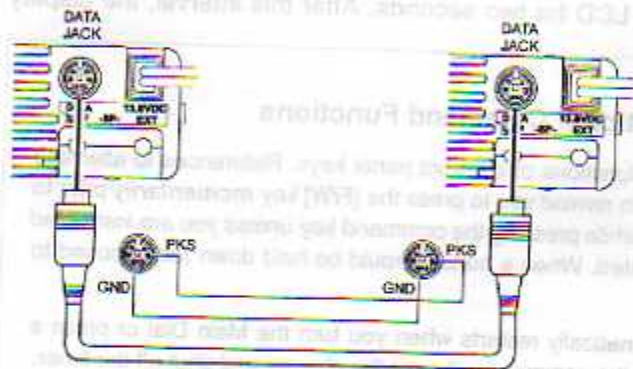

- Now, on the "source" radio, press the **[RPT]** key. The source transceiver will now send its entire memory and VFO data map to the target radio. When the data has been successfully transferred, the display will again blink.
- Once the source radio's display begins blinking after the successful data transfer, turn the target radio off. Now turn the source radio off.
- Remove the Clone Cable. Channel and operating data for both radios are now identical. They both may be turned on now for normal operation.

## ADMS-2 Personal Computer Programming Kit

The ADMS-2 Programming Kit is a Windows™ -compatible package allowing quick and easy programming of all transceiver parameters from your home computer. Ideal for configuring your unit for special operating events either at home or while traveling, the ADMS-2 includes all cabling and software for "turn-key" programming.

As with most software packages, the ADMS-2 Programming Kit is available in different "versions," reflecting new Yaesu transceiver model introductions. Consult your Yaesu dealer for latest version configuration and pricing information. Complete installation and operation instructions are packaged with the ADMS-2.

## Operation

This chapter describes the transceiver functions in detail. After studying this information, we recommend that you keep the *FT-8000R Operator's Quick Reference Chart* handy in case you need to refresh your memory.

### Preliminary Setup

Before operating the FT-8000R for the first time:

- Connect an appropriate antenna to the antenna jack on the rear panel of the transceiver. *Never operate the transceiver without an antenna or dummy load connected.* Connect the DC power source in accordance with the Installation chapter.
- Connect the microphone and any other accessories, in accordance with the *Installation* chapter.

- Set both the left and right Volume and Squelch controls to their fully counter-clockwise positions.

### Turning the Power On/Off

Turn the transceiver's power on by pressing in the [PWR] switch. The transceiver is turned off in the same manner, only this time press and hold in the [PWR] key for ½ second.

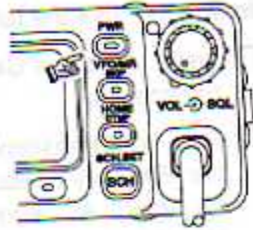

### Supply Voltage Display

When you turn on the FT-8000R, the current DC supply voltage is indicated on the right side of the LCD for two seconds. After this interval, the display

### Operating Instruction Conventions: Command Functions

Some operating commands utilize the so-called "Alternate" functions of the front panel keys. References to alternate functions have "[F/W] ⇒" in front of the key or button name, to remind you to press the [F/W] key *momentarily* prior to pressing the command key. Do *not* hold the [F/W] key down while pressing the command key *unless you are instructed to do so*, as you may get a different result than you anticipated. When a button should be held down (as opposed to being pressed momentarily), the instructions will say so.

A five-second timer starts when you push [F/W], and automatically restarts when you turn the Main Dial or press a front-panel key. Pressing a front panel key which completes the command will save the change and shut off the timer.



will assume its normal indication of the operating frequency.

To view the supply voltage at any time during operation, *press and hold in for 1/2 second the left Volume knob* (for voltage display on the left side of the LCD) or the *right Volume knob* (for voltage display on the right side of the LCD).

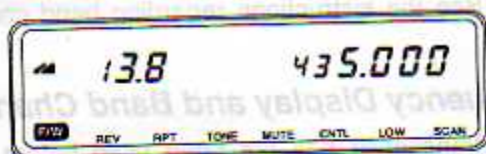

Note that this voltage display is the *net* supplied voltage to the transceiver, including any resistive losses in the DC cable. Therefore, it is typical (and normal) for this indication to be slightly lower than the voltage you measured directly at the battery or power supply output terminals. If the indication is below about 11.8 Volts, however, the transceiver may not operate properly, and you should investigate the cause of the low voltage (be *certain* to verify the reading with a separate voltmeter before making any changes). Excessive voltage drop may be caused by poor mechanical connections to the battery, a long DC cable of insufficient size (use #14 AWG or *larger* stranded wire if you must extend the cable), poor seating of the 15-Amp fuse in its holder in the DC cable, or insufficient battery voltage.

If you perform a "Hard Reset" of the transceiver's CPU (see page 60), the voltage display (which is calibrated through software) will also be reset to a possibly-inaccurate value. To re-calibrate the voltage display, see page 63.

### Adjusting the Volume and Squelch

Volume and Squelch are set independently for the VHF and UHF sides of the transceiver. The *left* Volume and Squelch controls provide adjustment for the *left* (VHF) side of the FT-8000R, while the *right* Volume and Squelch controls provide adjustment for the *right* (UHF) side.

Advance the setting of the appropriate Volume control for a comfortable listening level on the background noise or signals present on the band of interest.

When no signal is present, advance the Squelch control of each band just to the point where the background noise is just silenced. The "BUSY" indicator for the current band will disappear when the background

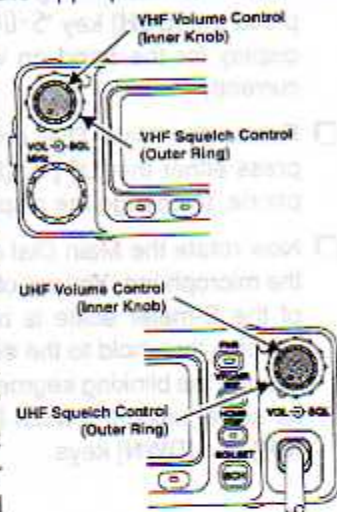

noise is silenced; if Intelligent Band Display (described later) is active, the Green LED for that band will also stop blinking when the noise disappears. Do not advance the setting of the Squelch control too far, as you will only be able to hear very strong local signals if the squelch is set too "tight." Leaving the squelch just past the threshold of noise silencing results in the best sensitivity.

A special **RF Squelch** feature is provided on the FT-8000R. This feature allows you to set the squelch so that only signals exceeding a certain S-meter level will open the squelch. To set up the RF Squelch circuit for operation, use the following procedure:

- Press and hold in the [FW] key for ½ second, then press the [SCH] key "5-0FF" will be shown on the display for the band on which you are operating currently.
- Rotate the Main Dial one click, or momentarily press either the [UP] or [DWN] key on the microphone, to change the display to "5-0n".
- Now rotate the Main Dial or press the [UP] key on the microphone. You will observe that one segment of the S-meter scale is blinking. Set the desired squelch threshold to the desired signal strength by moving the blinking segment up or down the S-meter scale, using the Main Dial or the microphone's [UP] and [DWN] keys.

- When the desired signal strength level for the squelch threshold is set, push the [SCH] key again.
- Finally, carefully advance the Squelch control for the band you are adjusting such that both edge segments of the S-meter scale (not including the "BUSY" indicator) for that band begin to blink.

This adjustment can be set independently for each band. See the instructions regarding band change below.

### Frequency Display and Band Change

If the transceiver has not been used before, the display will look something like this:

We call the frequency to the left the "VHF" channel, and the frequency to the right the "UHF" channel, even though (as we shall see later) the transceiver can accommodate two VHF channels or two UHF channels at the same time.

To establish the "Main" band (the one on which you will be transmitting), simply press the Volume knob for the left or right side momentarily, as appropriate. You will observe

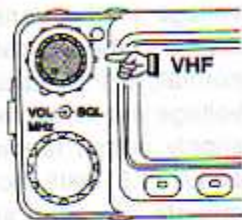

Selecting Main Band

the " " icon lighting up on alternate sides of the display as you switch "Main" bands from the VHF side to the UHF side, and vice-versa.

Initially, the transceiver will come on in the Dual Receive mode, wherein both the VHF and UHF receivers are active. Adjust the Volume and Squelch controls for each side to settings appropriate for your operating needs.

Hereafter in this manual, the band not designated as the "Main" band will be referred to as the "Sub" band. Only the Main band may be used for transmission; the Sub band is a receive-only channel.

### If nothing happens when you press a button . . .

the panel may be "locked" (this feature is normally used to prevent accidental changes to the settings of the controls and switches). If you see " " displayed on the left side of the LCD, press [FW] ⇒ [LOCK] to unlock the front panel. You may re-lock the front panel later by again pressing [FW] ⇒ [LOCK] to fix your settings and prevent tampering with them.

Downloaded by  
RadioAmateur.EU

### Note Regarding General Coverage Receiver Operation

Because there are several oscillators running continuously in the FT-8000R, it is inevitable that you will occasionally encounter a spurious response ("birdie") while tuning over the extremely wide frequency range covered by this transceiver.

Usually, these responses will only appear on one channel. They sometimes will appear on the Sub channel, for example, while tuning on the Main channel, as the latter's oscillators change frequency while you turn the Main Dial or scan. They are completely normal, and Yaesu's engineers have designed the frequency relationships in this transceiver so as to minimize the chance of one of these responses falling inside the Amateur bands.

The best way to avoid these encounters is to use Smart Search (described later) to find the active channels in your area, then load the desired channels into memory, where they can be included in your scanning loop.

### Intelligent Band Display (IBD)

The IBD feature, active by default, causes the appropriate band's Green LED to blink when a station is being received on that channel. This aids the operator visually in determining which band is receiving that station, in case you need to change "Main" bands for transmission.

To activate or deactivate IBD, use the following procedure:

- Press and hold in the [F/W] key for ½ second, then press [CNTL]. "ibd on" or "ibd off" will be displayed on the "Main" band display area.
- To change the IBD's state, once again push and hold in the [F/W] key for ½ second, then press [CNTL]. This action will "toggle" the IBD into its opposite state.

### Keypad Beeper

A key/button beeper provides useful audible feedback whenever a button is pressed. Each key and button has a different beep pitch, and each function has a unique beep combination. For example, when you press the VHF Volume knob, you will hear a low-pitched beep *followed* by a high-pitched beep if switching the Main Band from UHF to VHF, but you will hear a high-pitched beep followed by a low-pitched beep if you switch the Main band from VHF to UHF.

If you want to turn the beeper *off* (or back on again):

- Press [F/W] ⇒ [TONE], and observe the small "b" in the upper-left-hand corner of the display area.
- Now press [F/W] to make the "b" disappear and switch off the beeper. Pressing the [F/W] key again will restore beeper operation, and the small "b" will reappear.
- When you are done, press [TONE] to save your new setting and exit to normal operation.

The sound of the key beeper can also be changed; when the Key Lock is active, you can have the key beeper emit DTMF tones from the speaker, instead of the (default) "Do-Re-Mi" sounds. To do this, turn the transceiver off. Now press and hold in the [TONE] key (the 4th key from the left along the bottom) while you turn the transceiver on. Now, when you have the Key Lock engaged, pushing a key will cause a DTMF tone to be emitted. To revert to the "Do-Re-Mi" tones, repeat this switch-on procedure.

### Display Brightness

The Omni-Glow display illumination has been specially engineered to provide high visibility with minimal disruption of your "night vision" while you are driving. The brightness of the display is manually adjustable, using the following procedure.

- Press [FW] momentarily, then rotate the Main Dial. You will observe the brightness of the display changing.
- When you have found a comfortable brightness level, simply push in the Main Dial momentarily to save your new setting and exit to normal operation.

### Frequency Selection: "Dial" (VFO) Mode

This mode is used for selecting a frequency within the selected band of operation. In the "Dial" mode, the Main Dial and microphone [UP] and [DWN] buttons allow the Variable Frequency Oscillator (VFO) to tune in the selected step size (or in 1 or 10 MHz steps). When scanning in the Dial mode, the same step sizes are used as in manual tuning.

The maximum tuning range, where permitted, is 110-280 MHz on the "VHF" VFO, and 280-550 plus 750-1300 MHz on the "UHF" VFO. Therefore, if you want to cross the boundary at 280 MHz, you will have to switch frequency control from the VHF channel to the UHF channel, or vice-versa, by



or

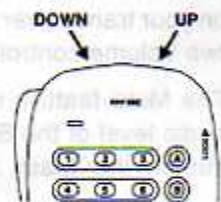

selecting a new "Main" band (or by pressing the [CNTL] key, as we shall see later).

After designating the Main band to be used, select the MHz range in which you wish to operate. To do this, *press* the Main Dial momentarily, then *rotate* the Main Dial. All the MHz digits of the frequency display will blink while "1 MHz Tuning" is enabled.

Once you have selected the desired 1 MHz range in which you wish to operate (e.g. 145 MHz), press the Main Dial again (momentarily). Now you may rotate the Main Dial to tune around the band in the selected synthesizer steps.

If you wish to make a *major* frequency excursion:

- First press and hold in the Main Dial for ½ second. You will observe that the first two digits of the frequency are blinking, as you have now selected the "10 MHz Step" frequency selection mode. Above 999 MHz, the first three digits will blink during this step.
- Rotate the Main Dial to select a 10 MHz multiple nearest the desired operating frequency. Once you have reached the nearest 10 MHz step, press the Main Dial momentarily, to put the transceiver in the "1 MHz Step" tuning mode, as described previously.
- Now rotate the Main Dial to select the desired 1 MHz segment, then press the Main Dial momentar-

ily again. The transceiver will now be ready for tuning the band in its regular tuning steps.

### Channel Step Selection

Tuning steps are factory preset to default increments which are appropriate for the country to which the FT-8000R is exported. To change to another step size, press [F/W] ⇒ [STEP] (the "alternate" function of the [REV] key). Now rotate the Main Dial to select a different step: 5, 10, 12.5, 15, 20, 25, or 50 kHz per step. The "5" or "P" in the memory box is the "Scan Mode" indicator, described later.

Once the desired step size is displayed on the LCD, press [REV] again to save your selection and return to the operating display.

Different synthesizer step sizes may be utilized on the VHF and UHF channels. Once you have selected the proper VHF step size, for example, press the right-side Volume control to designate UHF as the Main band, then press [F/W] ⇒ [REV] to inspect and/or change the UHF synthesizer steps (10, 12.5, 20, 25, and 50 kHz per step are available for UHF).

### VFO Tracking

The Main and Sub VFOs may be "slaved" together, so that rotation of the Main Dial (or stepping of the microphone [UP] or [DWN] keys) causes *both* VFOs to move in tandem. Each VFO will increment in the

step sizes that have been established by you previously, i.e. one step on VHF might be 5 kHz and one step on UHF might be 25 kHz, and the VFOs will advance by those increments during VFO Tracking operation.

To activate VFO tracking, push and hold in [F/W] for ½ second, then press the [UHF Band Volume Knob]. The "ω" icon will blink, and when you rotate the Main Dial you will observe that both VFOs are moving together. To cancel VFO tracking, press [VFO/MR] or [HOME].

Both Main and Sub bands must be in the VFO mode for this feature to work. VFO Tracking is similar, in principle, to "Memory Tracking," described on page 39.

### Receiver Muting

The Mute feature is useful in situations where you desire to reduce the level of the audio from the speaker *temporarily*. For example, if you receive a cellular telephone call in your car, it is often easier to lower the FT-8000R's audio by pushing one button on your transceiver than by adjusting the levels of the two Volume controls.

The Mute feature may also be used to reduce the audio level of the Sub receiver whenever you transmit on the Main channel. This will help reduce

feedthrough of UHF audio, for example, while talking on a VHF repeater.

To activate the Mute feature:

- ❑ First set the desired duration of receiver muting. The default Mute time, during which audio from both channels is reduced, is one minute (after which normal audio output resumes). Press [F/W] ⇒ [MUTE]; you will now observe the current Mute duration displayed in the frequency display area for the Main channel on the LCD.



- ❑ Rotate the Main Dial, or use the microphone's [UP] or [DWN] keys, to select a new Mute time, if desired. Push [MUTE] again to save your settings and exit.
- ❑ Now press [MUTE] once, momentarily. The "MUTE" icons on both the Main and Sub channel display are will blink, and you will observe that the audio level from both receivers has been significantly reduced. After the pre-programmed Mute



time period has elapsed, the "MUTE" icons will disappear, and normal audio output will resume.

- ❑ To mute the Sub channel's audio during transmission, press [F/W] ⇒ [MUTE], and observe the "t of" indication in the Main channel's memory label area. Now press [F/W] momentarily so that "t of" replaces "t of", indicating that the Transmit muting feature is activated. Press [MUTE] momentarily to save the new setting and exit. No further action is needed; the Sub channel will automatically be muted during transmission, without the necessity of again pushing the [MUTE] key.



## Monoband Operation

To *disable* one band (usually the Sub band), press [F/W] then one of the Volume knobs. The following rules govern the process of disabling one band:

- ☐ To disable the Sub band, while making no change to the Main band, press [F/W] ⇒ [Sub Band Volume Knob].  
To re-enable the Sub band, press [F/W] ⇒ [Sub Band Volume Knob].
- ☐ To make the current Sub band into the Main band, while simultaneously disabling the original Main band, press [F/W] ⇒ [Main Band Volume Knob].

To re-enable the Sub band (the first Main band will *not* revert to its original "Main" state), press [F/W] ⇒ [Sub Band Volume Knob].

- ☐ To change bands when the Sub band is blanked already, press [Sub Band Volume Knob] or [F/W] ⇒ [Main Band Volume knob].

See the chart below for a pictorial explanation of the selection flexibility available.

Remember that, if you are engaged in monoband operation only, the Sub band frequency display area can be set up to indicate the DC supply voltage. To do this *continuously* (as opposed to the two seconds

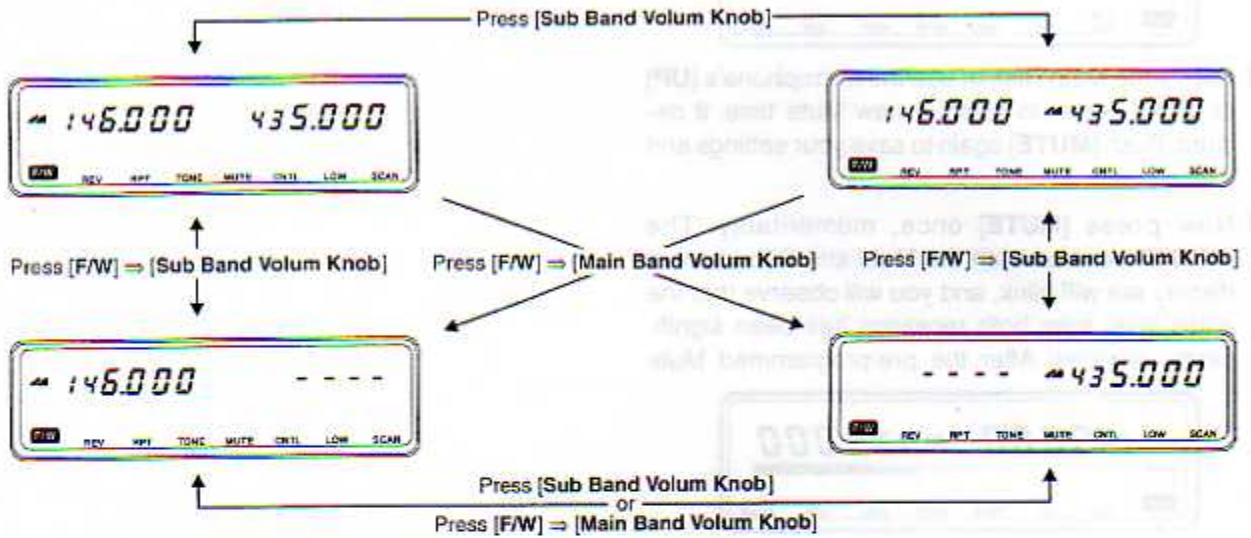



of voltage indication, as described on page 22), turn the transceiver *off*. Now press and hold in the *Right* Volume knob while you turn the transceiver on. In this condition, the input voltage display will replace the frequency display when you press [F/W] ⇒ [Sub Band Volume Knob]. To disable the voltage indication, repeat this process.



### VHF-VHF (V-V) or UHF-UHF (U-U) Operation

Dual-channel operation *typically* occurs when the left channel is set up for VHF, and the right channel is used on UHF. However, it is possible to operate the FT-8000R either in a V-V or U-U mode, if needed. Operation in either of these modes is easily enabled:

- If the "Main" band is VHF, press [F/W] ⇒ [CNTL]. The transceiver will now display replicate its VHF frequency on both left and right channels, and will be operating in the "V-V" mode.



- If the "Main" band is UHF, press [F/W] ⇒ [CNTL]. The transceiver will now replicate its UHF frequency on both left and right channels, and will be operating in the "U-U" mode.



While you are in V-V or U-U operation, you *cannot* change the "Main" band. This is a safety feature designed to maintain the priority of the *left* channel as the VHF channel, and the *right* channel as the UHF channel.

To return to "normal" VHF-UHF operation, press [F/W] ⇒ [CNTL]. The original VFO or Memory frequency for the Sub band will be restored.

During V/V or U/U operation, receive sensitivity and intermodulation rejection of the "Sub" receiver will be degraded slightly. However, this usually will not be noticeable except during operation in highly RF-congested areas.

### Sub Band Command Control

It frequently is necessary or desirable to make a change to the Sub channel without having to swap "Main" bands. The [CNTL] key allows all command functions *except transmit command* to be shifted from the Main channel to the Sub channel; this way,

you can reply without delay to an incoming call on the Main channel, but tune around or load memories, etc., on the Sub channel.

To enable Sub Channel Command Control, press [CNTL] momentarily. The Sub channel's Green LED will become illuminated; if a signal is present on the Sub channel, and IBD is active, the Green LED will blink. Now rotate the Main Dial; you will observe that the frequency will change on the *Sub* channel display, if you are in the VFO mode, or the channel number and frequency will change if you are in the Memory Recall mode. However, observe that the "M" icon has not moved, confirming that transmit command is still on the (unchanged) *Main* band.

You may change almost every aspect of the Sub channel's data after pressing the [CNTL] key, including frequency, repeater shift, CTCSS frequency, and Packet data rate. If you wish to *transmit* on the current Sub channel, though, you *must* assign it "Main" status by pressing the Sub Channel Volume Knob momentarily; doing this cancels the Sub Channel Command Control.

To do changes on the *new* Sub channel (the one which previously was the Main channel), press [CNTL] once again, then make the desired revisions.

Press [CNTL] to cancel Sub Channel Command Control.

## Transmission

To transmit, simply close the [PTT] (Push To Talk) switch on the microphone when the frequency is clear. Hold the microphone approximately 25 mm (1") from your mouth, and speak into the microphone in a normal voice level. When your transmission is complete, release the [PTT] switch; the transceiver will revert to the receive mode.

During transmission, the LED adjacent to the Main Band's Volume control changes from Green to Red, and the Bar Graph below the Main Band's frequency display deflects according to the power output selected.

### Power Output Setting

Three power output levels are available on the FT-8000R: 5 Watts ("L"), 10 Watts ("M"), and 50 Watts (VHF) or 35 Watts (UHF) on High (no indication), with icons indicating the *Low* and *Medium* power selections, if used.

To change the power level, press the [LOW] button below the LCD repeatedly until the appropriate power level is displayed. The power level may be stored in a memory register, if desired (see the chapter on "Memory Channel Storage and Recall" later).

Remember that the courteous operator always uses the minimum transmitter power necessary to establish and maintain reliable communications.

set at the factory to 600 kHz for the 144 MHz band and 1.6 MHz, 5.0 MHz, or 7.6 MHz for the 430 MHz band (depending on the transceiver version). Note that only one offset at a time can be used on each band with the manual and ARS methods. Use the independent transmit frequency method when you want to store other offsets, such as frequencies of repeaters with non-standard splits. This technique is described later under *Separate Transmit Frequency Memories*.

① **Standard Repeater Shift**

To activate the standard shift manually, press the [RPT] key: once for "Minus" shift, again for "Plus" shift, and a third time to return to **Simplex**. A small "+" or "-" sign will appear just above the frequency display field on the LCD whenever a repeater shift has been activated.



**Example:** To operate on a 146.34/146.94 MHz repeater:

- Press the left Volume control, if necessary, to select the 2-meter band as the Main channel. Rotate the Main Dial to set 146.940 MHz as the receive frequency (the output frequency of the repeater).

- Press [RPT] once. A "-" should appear above the "146.940" frequency display field on the left side of the LCD (if not, press [RPT] repeatedly until it does).
- When the channel is clear, press the PTT switch on the microphone, and identify your callsign. As you transmit, you will observe that the frequency has shifted to 146.340 MHz (the repeater input frequency).

With repeater shift activated, you can temporarily reverse the transmit and receive frequencies by pressing the [REV] key. Use this key to display the transmit frequency *without transmitting*, and to check the strength of signals on a repeater uplink frequency (so as to determine whether or not a particular station is within "Simplex" range, for example). The repeater shift indicator *blinks* while "Reverse" shift is activated. Press [REV] again to revert to the normal shift direction.



The above example presumes that the 2-meter repeater offset is set to 600 kHz, as supplied from the factory. If the offset is *not* 600 kHz, you can change it by following this procedure:

set at the factory to 600 kHz for the 144 MHz band and 1.6 MHz, 5.0 MHz, or 7.6 MHz for the 430 MHz band (depending on the transceiver version). Note that only one offset at a time can be used on each band with the manual and ARS methods. Use the independent transmit frequency method when you want to store other offsets, such as frequencies of repeaters with non-standard splits. This technique is described later under *Separate Transmit Frequency Memories*.

① *Standard Repeater Shift*

To activate the standard shift manually, press the [RPT] key: once for "Minus" shift, again for "Plus" shift, and a third time to return to **Simplex**. A small "+" or "-" sign will appear just above the frequency display field on the LCD whenever a repeater shift has been activated.



**Example:** To operate on a 146.34/146.94 MHz repeater:

- Press the left Volume control, if necessary, to select the 2-meter band as the Main channel. Rotate the Main Dial to set 146.940 MHz as the receive frequency (the output frequency of the repeater).

- Press [RPT] once. A "-" should appear above the "146.940" frequency display field on the left side of the LCD (if not, press [RPT] repeatedly until it does).
- When the channel is clear, press the PTT switch on the microphone, and identify your callsign. As you transmit, you will observe that the frequency has shifted to 146.340 MHz (the repeater input frequency).

With repeater shift activated, you can temporarily reverse the transmit and receive frequencies by pressing the [REV] key. Use this key to display the transmit frequency *without transmitting*, and to check the strength of signals on a repeater uplink frequency (so as to determine whether or not a particular station is within "Simplex" range, for example). The repeater shift indicator *blinks* while "Reverse" shift is activated. Press [REV] again to revert to the normal shift direction.



The above example presumes that the 2-meter repeater offset is set to 600 kHz, as supplied from the factory. If the offset is *not* 600 kHz, you can change it by following this procedure:

- ❑ Set the Main channel to the band on which the offset is to be changed (in the above example, we were on the 144 MHz band).
- ❑ Press [F/W] ⇒ [R.SET] (the "alternate" function of the [RPT] key) to display the current offset. The current repeater offset, in MHz, to 3 decimal places, appears in place of the operating frequency display.



- ❑ Select the desired offset with the Main Dial or microphone [UP/DWN] buttons and, if needed, by pressing the Main Dial momentarily to enable the "MHz Set" mode, as described on page 27. Note that the resolution of the "standard" repeater shift is to the nearest 50 kHz multiple (e.g. 700 kHz or 850 kHz, but 675 kHz is not permitted).
- ❑ Once the desired repeater shift, in MHz, is set, press the [RPT] key to save your setting and exit to normal operation.

It generally is recommended that the standard repeater shifts not be changed, unless you have a compelling reason for doing so. Non-standard repeater shifts (including those *not* a multiple of 50 kHz) can easily be accommodated by referring to the

section describing *Separate Transmit Frequency Memories* below.

② *Automatic Repeater Shift*

The ARS (**A**utomatic **R**epeater **S**hift) feature in the FT-8000R allows easy and convenient repeater operation by automatically activating the repeater shift function whenever you tune to a standard repeater sub band. The ARS function is preset at the factory to conform to the standards for the country to which it is exported.

**ARS-Repeater Subbands**

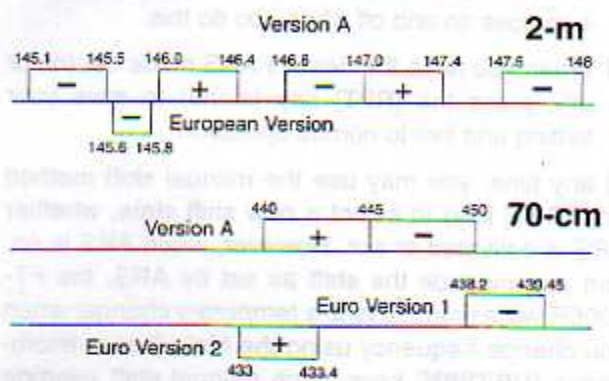

As with "manual" repeater shift operation, a small "+" or "-" sign will appear above the frequency display field for the band on which you are operating when the shift has been activated by the ARS feature.

The ARS function is *enabled* at the factory. To *disable* it on the Main channel:

- Press [F/W] ⇒ [R.SET] (as you did previously in setting the standard repeater shift). If the ARS is enabled, a small "R" will appear above the "M" ("Main Channel") icon.



- Now press the [F/W] button (alone) to toggle ARS on and off for the Main channel. Note that the "R" icon goes on and off when you do this.
- When you have the desired ARS mode set (on or off), press the [RPT] key (alone) to save your setting and exit to normal operation.

At any time, you may use the manual shift method (the [RPT] key) to select a new shift state, whether ARS is activated or not. However, when ARS is on, and you *override* the shift as set by ARS, the FT-8000R will assume this is a *temporary* change; when you change frequency using the Main Dial or microphone [UP/DWN] keys, such manual shift override commands are *anceled*, and operation will resume using the standard ARS repeater offsets appropriate for the portion of the band in which you are operating.

ARS operation is independent on the VHF and UHF channels. Therefore, you are allowed to have ARS enabled on UHF but *disabled* on VHF, if you wish. Simply follow the procedure just described separately for each band.

### ③ Separate Transmit Frequency Memories

All memory channels can store independent receive and transmit frequencies, to accommodate occasional non-standard offsets with greater frequency resolution than is available using the "standard" storage feature. Comprehensive information on storage and recall of memory channels begins on next page. It may be useful to read that section of the manual first, then return to this section, if you are not familiar with the procedures used in memory storage.

- First store the *receive* (repeater output) frequency. In the VFO mode, tune the transceiver to the desired receive frequency. Now press and hold in the [F/W] key for ½ second; a memory number or letter will *blink* in the upper-left-hand area of the frequency display field for the band on which you are operating.

Within five seconds of pressing [F/W], use the Main Dial or microphone [UP/DWN] buttons to select the desired memory for storage.

Now press [F/W] again *momentarily* to store

receive frequency into the selected memory. The memory label will stop blinking for a second, then disappear.

- Next store the *transmit* (repeater input) frequency. Since you are still in the VFO mode, tune the transceiver to the desired transmit frequency.

Now press and hold in the [F/W] key, as before, to cause the memory label to blink again. *Do not change the memory label number!*

Press and hold in the microphone [PTT] switch, and then press [F/W] while holding in the [PTT] switch. This will not cause transmission, but rather it will instruct the transceiver that you are *programming* a separate transmit frequency into memory.

Whenever you recall a separate transmit frequency memory, a special "-/+" icon will appear at the upper edge of the display, indicating that a non-standard split is in use. You may use the [REV] key to check the input frequency of an odd split memory, just as though it were a standard offset.

Odd splits can only be programmed, pursuant to this chapter, on the Main band, since the action of the microphone PTT switch has no effect on the Sub channel at any time.

After storing a memory with a separate transmit frequency, if you re-write the receive frequency, the

separate transmit frequency will be *deleted*. There is no need to delete the separate transmit frequency memory register itself.

## Memory Storage

The FT-8000R provides 54 memories per band, plus one HOME channel on each band, for a total of 110 available memories. The memories are labeled 1-50, 1L, 1U, 2L, and 2U. All memories can store standard repeater shifts or independent TX/RX frequencies, CTCSS data, transmit power level, and Packet baud rate data. This section describes the general purpose functions of the memories; the 1L, 1U, 2L, and 2U memories can also be used to store programmable band scanning limits, as described later.

To store a frequency into memory:

- In the VFO mode, select the desired frequency, repeater shift, CTCSS tone (see page 49), TX power level, and, if this is a packet channel, the desired baud rate (1200/9600) (see page 54).
- Press and hold in the [F/W] key for ½ second. A memory number or letter will appear blinking along the top edge of the frequency display field of the LCD on the band on which you are operating.
- Within five seconds of pressing [F/W], use the Main Dial or microphone [UP/DWN] keys to select the desired memory for storage. If you select one that

was already being used, a lower-case "a" (for "Occupied") will appear in the left side of the memory label field; the original memory data will, in this case, be *over-written* with the new data when you complete the next step.

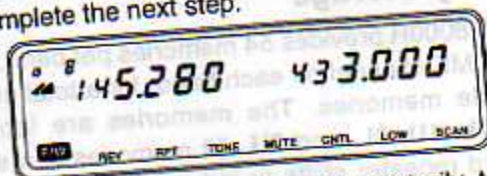

- Press [F/W] again, this time momentarily, to store the displayed data into the selected memory channel slot. The memory label will stop blinking for a second, and then will disappear (since you are still operating in the VFO mode).

**Example:** Store 146.340/146.940 MHz into Memory Channel 5:

- ① Use the example on page 34 to set up the desired frequency and offset on the Main VHF channel's VFO.
- ② Press and hold in the [F/W] key for ½ second to display the memory label along the top edge of the frequency display field. *Do the next step within five seconds!*
- ③ Rotate the Main Dial so that "5" (the memory slot to be used) appears in the memory label field.

- ④ Press [F/W] again momentarily. Memory storage is now complete. The VFO data has been stored into memory channel #5 for the VHF band.

Note that you will remain in the VFO mode until you change to the **MR (Memory Recall)** mode (described next); this allows you to program multiple frequencies from the VFO mode efficiently.

### Recalling Memories

From the VFO mode, pressing [VFO/MR] activates the memory mode.

To confirm that the just-described memory storage was successful, rotate the Main Dial to change the VFO frequency (to anything else), then press [VFO/MR] to change from the VFO mode to the "MR" (Memory Recall) mode. The numeral "5" should appear in the memory label field, and 146.940 MHz (the receive frequency) should appear on the frequency display. Press [REV] once to confirm the transmit frequency of 146.340 MHz, then press [REV] again to return to normal operation.

When more than one memory has been stored, use the Main Dial to select a memory for operation. Alternatively, the microphone's [UP] or [DWN] key may be used to step or scan through the available memories on the current band. When using the microphone's keys, press and release the button to move one step



up or down; press and hold in the [UP] or [DWN] key for ½ second to begin memory scanning.

## Alternating-Band Memory Selection (ABMS)

If you want to select among previously-stored memories on *both bands*, use the Alternating-Band Memory Selection feature. To activate this feature (you must be in the MR mode on both bands), press and hold in [F/W] for ½ second, then momentarily press the Volume knob for one of the bands; the operation thereafter will depend on *which* Volume button you press:

- Pressing [F/W] for ½ second, then [VHF Band Volume Knob], causes normal ABMS operation, where the transceiver will step from Channel 1 (VHF) to Channel 1 (UHF), then to Channel 2 (VHF) and Channel 2 (UHF), etc.



- The "Link" icon ( "∞" ) will be displayed at the center of the display, and memory selection will

alternate between the VHF memory bank and the UHF memory bank as you rotate the Main Dial (or scan) in the MR mode.

- Pressing [F/W] for ½ second, then [UHF Band Volume Knob], causes the "∞" icon to *blink*, and the FT-8000R will then enter a "Memory Tracking" mode: if you rotate the Main Dial, or press and hold in the [UP] or [DWN] keys, both Main and Sub band memories will advance in parallel one step at a time. If you have been holding in one of the microphone scanning keys, and then release it, the Main band will begin normal high-speed scanning when you release the key. Press [PTT] to halt the scan.



If you have activated scanning on *both* the Main and Sub channels in this mode, they *both* will follow the alternate-band memory selection technique when the "∞" is displayed.

This feature is *disabled* when both Main and Sub

displays are set to the same band (V-V or U-U operation).

To cancel Alternating Band Memory Selection, press [HOME] or [VFO/MR].

### Home Channel Memories

Convenient one-touch "Home" channel memories (one per band) are available to simplify return to your most-often-used frequency. These memories do not appear in the regular memory banks, to simplify operation.

To recall the Home channel on the Main band, just press the [HOME] key; to recall the Sub band's Home channel, press [CNTL] ⇒ [HOME]. The "H" notation will appear in the memory label field of the corresponding band.

The factory default frequencies for the Home channels are 145.000 MHz for VHF, and 433.000 MHz for UHF. You can re-program the Home channels in a manner identical to that used for the regular memories:

- From the VFO mode, tune in the frequency you wish to store, and set all repeater shifts and other data just the way you do for "normal" memory channel storage.
- Press and hold in the [FW] key for ½ second, then press [HOME]. If you need to store a non-standard

repeater shift, first store the receive frequency as we just did, then dial up the desired *transmit* frequency. Now press [FW] for ½ second, then press and hold in the microphone's [PTT] switch and hold it in while you press [HOME] again.

- To store the Sub band's data into that band's Home channel, first press [CNTL] to activate the alternate band's command functions, then follow the same steps as above.

Note that there is only one Home channel for each band, not one for the Main and one for the Sub. Therefore, if you are in V-V operation, pushing the Sub band's [HOME] key will result in the VHF Home channel appearing on the "UHF" channel's display (since that register had only temporarily been assigned to operation on VHF).

Press [HOME] once more to return to your last-used frequency (VFO or Memory).

### Memory Offset Tuning

While receiving in the MR mode (but not with Alternating Band Selection activated), you can *retune* the memory channel frequency as well as other "memorized" settings (like repeater shift). To do this, push in the Main dial momentarily. The "MT" icon will appear to the left of the frequency display field for the band in use. You can now tune off from the memorized

frequency as though you were in the VFO mode (including the use of the 1 MHz step feature).

The new frequency and other settings can be stored in the current memory, or can be committed to a new memory, as desired. Just press and hold in the [F/W] key for ½ second, select a new memory (if desired) by rotating the Main Dial, then press [F/W] again momentarily. Operation will remain on the *new* memory channel, and the original memory will revert to its *original* condition prior to the changes.



Memory Tuning Operation



Memory Mode



VFO Mode

After retuning a memory, if you don't want to save your changes, just press [VFO/MR] once; the FT-8000R will now return to the *original* memory data. One *more* press of the [VFO/MR] key will cause the transceiver to *exit* memory operation, and return to the VFO mode.

### Masking and Recovering Memories

With 110 total memories available, there frequently are situations where you may desire to "Mask" certain memories temporarily. For example, if you live in one city but frequently travel to another, you may wish to have ten memories stored and available for *each* city, but only utilize the ten memories for the city you currently are in. You can accommodate this need by Masking the ten unnecessary memories; they can be "Un-masked" later, without the need to re-program all the contents.

This feature is different from "Memory Skip Scanning," described later; Masking hides the memory contents during scanning and manual operation, while Memory Skip Scanning hides the memory contents *only* during scanning.

#### To Mask a memory:

- Recall the memory to be masked.
- Press and hold in the [F/W] key for ½ second, until the memory label blinks.

- Press the [REV] key. This will cause the display to change to Memory Channel 1, and the previously-selected memory to be Masked (not accessible during scanning nor by manual selection).

**To Un-mask a hidden memory, so as to restore operation:**

- Recall any memory.
- Press and hold in the [F/W] key for ½ second. The memory label will start blinking.
- While the memory label is blinking, rotate the Main Dial to select the memory channel number to be restored.
- Press the [REV] key momentarily (*not the [F/W] key!*).

When you have some memories masked, be careful not to over-write them accidentally. The previous contents will, as always, be lost if you over-write a memory channel register.

Downloaded by  
RadioAmateur.EU

## Scanning

Before activating the scanner, make sure that the SQL control is set to squelch off the background noise when no signal is present.

Scanning may be started or stopped with the microphone's [UP] or [DOWN] keys, or by pressing the [SCAN] key on the front panel of the transceiver. The following techniques are used for scanning:

- Pressing and holding in either the [UP] or [DWN] key for ½ second in the VFO mode will cause upward or downward *band* scanning, respectively, to begin.
- Pressing and holding in either the [UP] or [DWN] key for ½ second in the MR mode will cause memory channel scanning toward a higher- or lower-numbered *memory channel*, respectively.
- Pressing the [SCAN] key once will cause either band or memory scanning in an upward direction. A second push of the [SCAN] key will *reverse the direction* of the scan.
- Scanning pauses when a signal opens the squelch, and the decimal point on the display will blink. You can choose one of two scan-resume modes (described below).
- To halt the scan manually, the easiest way is to push the [PTT] switch on the microphone momentarily (no transmission will occur while you are

scanning). The scan may also be halted manually by pressing the microphone's [UP] or [DWN] keys, or the front panel [VFO/MR] key.

- When you have scanning active on the *Sub* band, and command control has been transferred to the Sub channel, scanning can only be halted manually by pressing the [VFO/MR] or [HOME] keys momentarily, since the action of the microphone's PTT switch has no effect on the Sub channel at any time.

### Scan-Resume Options

Two scan-resume modes are available on the FT-8000R:

- ① In the *Pause* mode, the scanner will remain halted for as long as there is a carrier present on the channel; after the carrier drops at the end of the other station's transmission, the scanning will resume.
- ② In the *5-Second* mode, the scanner will halt for five seconds *only*, after which scanning will resume (whether or not the other station is still transmitting).

To change the scan-resume mode, press [F/W] ⇒ [STEP] (the alternate function of the [REV] key). A small "P" or "S" will appear in the upper-left-hand corner of the frequency display field, indicating the current mode. If you want to change it, press [F/W]

momentarily. Press the [REV] key to save your new setting and exit.

### Memory Skip Scanning

When you have some continuously-active channels stored in memories (for example, weather-information broadcast stations), you may wish to *skip* them for scanning, but still have them available for *manual selection*.

To mark a memory to be *skipped* during scanning, press [F/W] ⇒ [SKIP] (the alternate function of the [VFO/MR] key). The "◀" and "SKIP" icons will become illuminated just to the right of the memory label whenever you pass by it during manual memory selection. During scanning, the memory channel so marked will be transparent.

To re-enable a "skipped" memory channel, just repeat the steps you took to disable it: select the memory channel manually, then press [F/W] ⇒ [SKIP].

### Programmable Band-Scan Limits

Besides band and memory scanning, the FT-8000R can be set to tune or scan only the frequencies between user-defined lower and upper limits. These limits are stored in special "Sub-Band Limit Memories" labeled 1L, 1U, 2L, and 2U, with the "L" and "U" designations representing the Lower and Upper lim-

its, respectively. To utilize this feature, use the following steps:

- Store the lower edge of the desired scanning/tuning range in memory 1L, and the upper edge in memory 1U (or, alternatively, in memories 2L and 2U).
- With any of these memories recalled, press the Main Dial knob momentarily. As described previously in the section on *Memory Offset Tuning*, the "MT" icon will appear on the LCD below the "M" icon. However, the frequencies stored in memories 1L and 1U (or memories 2L and 2U) will now serve

**Note:**

The frequency resolution for these sub-band limits is 100 kHz, although the channel resolution of the sub-band limit memories is whatever you have selected as the current step size. As a result, the frequencies stored in these special memories (1L, 1U, 2L, and 2U) are **both rounded down** to the nearest 100 kHz for their roles as sub-band limits.

Since the sub-band limit memories are otherwise indistinguishable from other memory channels, they may be used for any purpose either at the sub-band limit frequencies themselves, or anywhere in the 95 kHz **above** the sub-band limits, as "normal" memory channels. Thus, these special sub-band memories may be considered "two-in-one" memories.

as tuning and scanning limits, thus creating a tuning sub-band.

If either ARS or manual repeater shift is activated, repeater offset will be applied automatically *even if the resulting transmit frequency is outside the sub-band limits.*

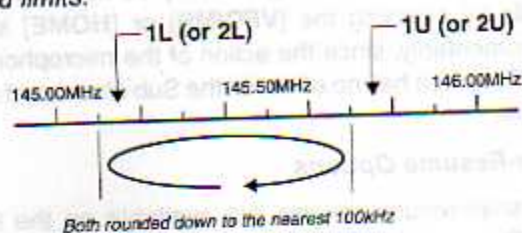

**Example:** To limit operation to 144.3-148.0 MHz, so as to avoid encroachment on the weak-signal portion of the 2-meter band (in North America):

- ① Set the Main display to the 2-meter band, and tune the Main Dial to any frequency between 144.300 and 144.395 MHz.
- ② Press and hold in the [FW] key for ½ second, and rotate the Main Dial so that "1L" appears in the memory label field. Now press [FW] again momentarily to complete the storage of 144.300 MHz as the lower sub-band limit (as noted previously, the actual frequency can be somewhat different — anywhere between 144.300 and 144.395 MHz — if you have a need to store a particular frequency in that range).



The Smart Search feature is especially useful when visiting a city for the first time, where you may be unfamiliar with the repeater frequencies; Smart Search will discover where the local activity is to be found, and will automatically load those frequencies for you.

Two modes of sweeping the band are available during Smart Search operation. They are:

- **One-Shot ("Single") Sweep**  
In this mode, Smart Search will sweep the entire band or within the Programmed Band-Scan Limits *one time*, and the sweep will halt thereafter, whether or not all 50 memory slots have been filled. The "S" icon will be displayed in the memory channel label field.



- **Continuous Sweep**  
In this mode, Smart Search will sweep the band (or within the limits) *continuously* until all 50 special memory slots have been filled. The "C" icon will be displayed in the memory channel label field. When all 50 memories are filled, the sweep will halt.



To set the Smart Search mode, press [F/W] => [SCH]. Either a "C" or "S" icon will be displayed in the memory label area of the display. Press [F/W] => [SCH] again to toggle to the opposite selection, if desired. The discussion to follow will assume that you have set the transceiver to the Continuous-Sweep ("C") mode (remember to confirm the setting for each band).

Smart Search operation is simple to activate:

- To sweep within the Programmable Band-Scan Limits, first recall Memory Channel 1L, 1U, 2L, or 2U. Now press and hold in the [SCH] key for 1/2 second, until sweeping begins. You will observe the blinking "S" icon on the left side of the display, along with a number that will increment upward; the latter is a counter for the Smart Search Memory Bank, indicating how many memories are currently filled.
- To sweep the entire band, begin in the VFO mode. Now press and hold in the [SCH] key for 1/2 second, until sweeping begins. You again will notice the blinking "S" icon, along with the Memory Bank counter.
- As the Smart Search feature encounters activity, the counter for the Smart Search Memory Bank will increase until it hits "25." If you started scan





at a band edge (or a sub-band limit), Smart Search will halt, and the "5" icon will blink; you may now rotate the Main Dial, or press the microphone's [UP] or [DWN] keys, to recall the Smart Search memories as though they were "regular" memories.

If ARS is active, and the stored Smart Search memories are in an appropriate repeater sub-band, you will observe that the appropriate repeater shift has automatically been appended to the frequency! You may transmit at will on these newly-stored memories, so long as they are on the "Main" band.

If you started Smart Search at some frequency other than the band edge or sub-band limit, the sweep will proceed upward in frequency until all 25 memories are loaded; thereafter, Smart Search will revert to the starting point for the sweep, and start scanning downward in frequency, loading up another 25 memories with a "-" sign ahead of the channel count in the memory label area of the display. If Smart Search encounters the lower band edge before all 25 "minus" memories are loaded, it will loop to the upper band edge (or sub-band limit), continue sweeping downward from that point, and will proceed in search of new channels to load until all 25 are loaded.

During Continuous sweeping, if Smart Search encounters a "duplicate" active frequency (one already loaded from a previous loop), the duplicate will be ignored.

Note that these memories are so-called "soft" memories; they will be lost if you move to and from V-V or U-U operation during Smart Search, so it is recommended that you *store* any particularly "interesting" frequencies encountered by Smart Search into a *regular* memory. To do this, follow the same procedure you do for normal memory storage:

- While the "5" icon is blinking to indicate that you are utilizing a Smart Search memory, rotate the Main Dial, or press the microphone's [UP] or [DWN] keys, to select the soft memory you wish to store.
- Press and hold in the [F/W] key for ½ second; the blinking Smart Search memory label will be replaced by a blinking *regular* memory label.
- Rotate the Main Dial, or press the microphone's [UP] or [DWN] keys, to select the regular memory slot into which you wish to re-assign the "soft" memory.
- Press [F/W] again. The soft memory will now be stored into the selected memory slot, and the display will revert to the Smart Search mode (with the blinking "5" icon), since you have not executed a command to change from the Smart Search mode.

To cancel Smart Search, press [HOME] or [VFO/MR].

### Priority Channel Monitoring

The Priority function allows automatic checking for activity on a particular memory every five seconds while operating on the VFO or a different memory. When the receiver detects a signal on the designated "Priority" memory, operation automatically shifts to that memory while the signal is present (plus a few seconds). If you *transmit* while "paused" on the Priority channel, Priority monitoring will cease, and the transceiver will "hold" indefinitely on the Priority channel.

We recommend that Memory Channel 1 for both VHF and UHF be reserved by you as the main "Priority" channel, as the transceiver will *only* check *Memory Channel 1* as the Priority channel if you are operating in the **MR** mode. However, if you are operating in the VFO mode, Priority operation will define the *last-used memory channel* as the Priority channel while you are tuning around the band using the **VFO**.

To set up for Priority monitoring:

- Preset the SQL control to silence the background noise on a clear channel, then store the frequency to be the "Priority" channel into a memory location (this must be Memory Channel 1 if you will be

operating on other *memories* during Priority monitoring).

- Press [VFO/MR] to operate in the VFO mode. If you are in the MR mode, select the memory on which you wish to operate (other than the Priority channel).
- Now press [F/W] ⇒ [Main Dial]. The "P" notation will appear in the memory label field for the Main channel; about every five seconds, the displayed frequency will shift to the Priority memory briefly while the receiver checks for the presence of a signal.

When no signal appears on the Priority memory (causing the squelch to open), you can tune, transmit and receive on the VFO, or select and operate on other memories; however, you cannot scan (except manually, using the microphone's [UP] and [DOWN] keys), as the scanning logic circuits are already dedicated to the Priority scanning activities.

If a station you wish to talk with appears on the Priority memory, press the [PTT] switch momentarily while receiving their signal (no transmission will occur) to *halt* Priority scanning. Otherwise, when a signal appears on the Priority memory, priority monitoring will pause and the decimal on the display will blink. Priority monitoring will resume based on the setting of the regular Scanning-resume mode.

either after a 5-second pause, or after the carrier drops out.

To cancel Priority monitoring, press [VFO/MR] or [HOME].

A few other rules govern Priority operation:

- ① You may use any available memory as a Priority channel in the above procedure when you are operating in the **VFO** mode. You may *not*, however, switch from the MR mode to the VFO mode, or vice-versa, without first *canceling* Priority monitoring (by pressing [VFO/MR]).
- ② You cannot scan on the VFO you are using during Priority operation on that channel (either Main or Sub). However, during V-V or U-U operation, you *may* be engaged on Priority monitoring on the Main channel while band-scanning on the same frequency band (e.g. 2 meters) on the Sub channel, or vice-versa.
- ③ You may operate *both* the Main and Sub channels in the Priority mode, effectively permitting the monitoring of *four* frequencies at once (two on each receiver channel).
- ④ During V-V or U-U dual-receive operation, if you switch bands (from VHF to UHF) during Priority monitoring, the Priority function will remain enabled, although it will be *suspended* until you return to that band (since both Main and Sub

channels will be on the opposite band from that on which you are Priority monitoring, this condition will be transparent to the user).

- ⑤ The Priority function is not disabled by switching the transceiver off. If you were engaged in Priority monitoring at the moment you turned the radio off, it will *assume* that you will want to continue Priority monitoring during your *next* operating session, and will come up still in the Priority mode when the transceiver is switched back on.

### CTCSS Operation

The built-in CTCSS Tone Encoder provides a subaudible tone, superimposed on your transmitted voice signal, to allow access to repeaters and remote bases requiring a CTCSS tone for access.

If the optional FTS-22 CTCSS Decoder Unit is installed, you can silently monitor for calls on busy channels, with your receiver's squelch only opening up when a signal bearing the matching CTCSS tone appears on your frequency. A special "CTCSS Bell" feature also will sound an alert tone, if you like, to advise you that a call is coming in. The FTS-22 option includes separate decoders for the Main and Sub channel. Installation of the FTS-22 is described at the back of this manual.

To operate using CTCSS, there are two steps required:

- ① The CTCSS tone frequency must be set correctly, and
- ② The CTCSS feature must be activated in the desired mode.

In other words, the act of *setting* the CTCSS tone frequency does not *itself* turn the CTCSS feature on; the "Tone Set" mode acts as a "scratch pad" to tell you which tone frequency will be utilized when you turn CTCSS on.

67.0	69.3	71.9	74.4	77.0	79.7	82.5
85.4	88.5	91.5	94.8	97.4	100.0	103.5
107.2	110.9	114.8	118.8	123.0	127.3	131.8
136.5	141.3	146.2	151.4	156.7	162.2	167.9
173.8	179.9	186.2	192.8	203.5	210.7	218.1
225.7	233.6	241.8	250.3			

To check or set the CTCSS tone frequency:

- Press [F/W] ⇒ [T.SET] (the alternate function of the [TONE] key); the tone frequency in Hz will be shown in the frequency display field.
- To *change* the tone frequency, rotate the Main Dial or press the microphone [UP] or [DWN] keys until the display shows the desired tone frequency (see the Table in this section).

- Press [TONE] to save your selection and return the display to the operating frequency.

To *activate* CTCSS Encode operation:

- Press [TONE] while the operating frequency is displayed. The "ENC" notation will appear along the top edge of the frequency display for the current Main band. The CTCSS tone, set to the subaudible frequency just selected, will be superimposed on the transmitted carrier from your transmitter.

- If you press [TONE] again *without the FTS-22 option being installed*, the encoder will turn off.

To activate CTCSS *Decode* operation (requires optional FTS-22 Decoder module):

- If CTCSS is off, press [TONE] *once* to activate the Encoder ("ENC" will become illuminated), then push [TONE] *again* to activate the Decoder ("DEC" will become illuminated next to the "ENC" icon). The receiver will become silent, unless a station bearing a CTCSS tone matching that of *your* transmitter appears on frequency. When this happens, the squelch will open and normal reception will commence.

- If signals are present on your current operating frequency that are *not* transmitting using a matching tone, the "BUSY" icon for that band will be illuminated, but no audio from that station will be

heard.

This alerts you to the fact of non-CTCSS operation on the channel, and you should not transmit (and cause interference to the other stations) under this circumstance.

- During CTCSS Decode operation, push [TONE] once to cancel CTCSS operation.

CTCSS tones and tone modes (Encode and/or Decode) may be stored in each memory. Simply remember to set up the CTCSS frequency, and activate CTCSS into the Encode or Encode/Decode mode, *while in the VFO mode* prior to memory storage.

When operating in the MR mode, you may change CTCSS tone frequencies and tone modes at any time by following the procedures just described. However, the transceiver will *assume* that any changes you make are *temporary changes unless you store the changes into the memory on which you are operating*. To make a *permanent* change, recall the memory channel, make the changes to the CTCSS frequency and/or Encode or Encode/Decode state, then push and hold in [F/W] for ½ second; then, within five seconds (while the current memory channel number is blinking in the memory label field), press [F/W] again momentarily to save your changes in the current memory.

The Sub channel display can also show the "ENC" and "DEC" icons if the CTCSS feature is active on the Sub band. Of course, since the Sub band cannot be used for transmitting, the "ENC" notation is merely a "What if?" advisory, letting you know that the CTCSS Encoder will be active *when* you make the current Sub channel into the Main channel. You may, however, make changes to the Sub channel's CTCSS conditions by pushing [CNTL], then performing the desired operations on the Sub channel. During Dual Receive operation, the Sub band's CTCSS Decoder, if installed and activated, *is* functional.

### CTCSS Bell Paging with the FTS-22

CTCSS Bell operation is very similar to the CTCSS Encode/Decode operation just described, in that subaudible tones cause the squelch to open. However, if you are waiting for a call, it sometimes is helpful to have the transceiver "ring" to get your attention.

The CTCSS Bell mode displays small "🔔" icons to the right of the frequency display field for both the Main and Sub channels. When you receive a matching CTCSS call, the transceiver rings like a telephone, after which the small bell on the appropriate display field blinks to indicate (A) that you received a call, and (B) on which channel (Main or Sub) the call came in. Since CTCSS Bell operation requires CTCSS

Decode capability, the optional FTS-22 must be installed for CTCSS Bell operation to be available.

To activate CTCSS Bell operation:

- Tune to the desired frequency on the Main band, then select a CTCSS tone frequency as described on page 50, if you have not done so already.
- If it is not already enabled, activate CTCSS Encode/Decode by pushing [TONE] ⇒ [TONE] (if CTCSS is off) or [TONE] (once only, if the Encoder is already on).
- Press [F/W] ⇒ [HOME]. The small "▼" icon appears to the right of the Main channel's frequency display, and CTCSS Bell operation is now enabled.
- To enable CTCSS Bell operation on the Sub channel, press [CNTL] first, then repeat the above procedure on the Sub display side. The "Link" ("ω") icon will be illuminated when you push [CNTL], then the "▼" will appear after you push [F/W] ⇒ [HOME].

Once CTCSS Bell operation is enabled, all calls on the channel in use *without a matching CTCSS tone* will be *ignored* by the FT-8000R's receiver. Any call received *bearing* the matching tone will cause the transceiver to ring, and the squelch will stay open while the other person transmits. The "▼" icon will blink, and will continue to do so until you reset it by

pressing the [PTT] switch, [VFO/MR], or by retuning the Main Dial.

Once you receive a call, *disable* the CTCSS Bell feature to prevent its ringing every time the other station transmits. Press [F/W] ⇒ [HOME] to disable CTCSS Bell operation.

Note that the other station does not need to be using the CTCSS Bell feature in order to have *your* CTCSS Bell function. The other station only needs to have a CTCSS encoder active and set to the same CTCSS frequency as your FT-8000R's CTCSS *Decoder*.

The CTCSS Bell system is channel-specific (Main vs. Sub), but CTCSS Bell status (On/Off) cannot be stored into a memory register. CTCSS tone frequencies and Encode/Decode status, as mentioned previously, *can* be stored in memories; once this is done, just push [F/W] ⇒ [HOME] to enable or disable CTCSS Bell operation on the current channel.

### DTMF Autodialer Operation

Two DTMF Autodialer memories, one for the Main channel and one for the Sub channel, are available on the FT-8000R. These DTMF Autodialer memories can store up to 16 digits of a telephone number for repeater autopatch or other use.

To load a DTMF Autodialer memory, use the following procedure:

- On the Main band, press and hold in the [F/W] key for ½ second, then press [VFO/M] momentarily. The frequency display will be replaced by a series of hyphens, the leftmost of which will *blink*.
- Rotate the Main Dial (or use the microphone's [UP/DWN] keys) to select the numerical value of the first digit in the telephone number to be memorized. The value selected will appear in the memory label field in the upper-left-hand corner of the display area.
- Push the Main Dial in momentarily to lock in your selection. The blinking hyphen will shift one position to the right.
- Once again, rotate the Main Dial to select the next digit in the telephone number, then press the Main Dial momentarily to lock in the second digit selection.
- Repeat this process until all digits of the telephone number have been selected. If you make a mistake in entry, use the [HOME] key to *backspace* through the telephone number to a previous digit. To delete *all* digits and start over, press [REV].
- When the telephone number is complete, press [VFO/MR] to save your settings and exit to normal operation.
- If you wish to *monitor* the sound of the DTMF tone sequence without transmitting, press [TONE] at

any time during the entry process (after you have pressed [F/W] and [VFO/MR] at the start of this procedure).

- You may now store a DTMF memory on the opposite channel of the transceiver, either by changing "Main" channels or by pressing [CNTL] prior to beginning the above loading procedure. Remember to press [CNTL] when finished, to return control functions to the Main channel.

To *transmit* the memorized telephone number, push and hold in the [PTT] switch and press [HOME/DTMF].

The speed at which the DTMF digits are sent can be changed. Two speed levels are available: Low (5 digits per second—the default setting) and High (9 digits per second). To toggle between Low and High speed, turn the transceiver off, then push and hold in the [HOME] key while turning the transceiver on. To revert to Low speed, repeat this procedure.

Note that repeater autopatches invariably require an "access code" to be sent prior to the dialing of a telephone number. Since there is only one DTMF Autodialer memory available per channel, this access code must be sent manually.

## Packet Operation

Packet operation only requires that you define the baud rate at which you wish to operate, 1200 bps or 9600 bps, and that you connect your TNC, in accordance with the instructions on page 19, for the data speed to be used.

To select the Packet baud rate:

- Select the band on which you wish to operate by establishing that band as the "Main" band.
- Push and hold in the [F/W] key for ½ second, then press the [TONE] key. If "9600" is displayed on the LCD (below the UHF channel's "BUSY" icon), the FT-8000R is in the "9600 bps" mode. If the "9600" icon does *not* appear, then the transceiver is in the "1200 bps" mode.
- You may toggle the baud rate by again pressing [F/W] for ½ second, then pressing [TONE].
- The Packet baud rate selection can be set independently for each band (VHF and UHF), and note that this data may be stored in memory channels. Therefore, if you have several 1200 bps and several 9600 bps frequencies which you wish to memorize, just set the data speed to 1200 while in the VFO mode, store those channels, then toggle to 9600 bps prior to storing the high-rate frequencies into memory.

Data Jack Pin Connections

Pin	Label	CT-39 Wire Color	Notes
1	PKD	Orange	Packet Data Input: Impedance: 10 kΩ Max. Input Level: 40 mV pp @ 1200 bps 2.0 V pp @ 9600 bps
2	GND	Yellow	Signal Ground
3	PKS	Red	Ground to Transmit
4	RX9600	Green	9600 bps Packet Data Output: Impedance: 10 kΩ Max. Output: 500 mV pp
5	RX1200	Violet	1200 bps Packet Data Output: Impedance: 10 kΩ Max Output: 300mV pp
6	SQL	Black	Squelch Control: Squelch Open: +5V Squelch Closed: 0V

During packet operation using the rear panel DATA jack, the microphone need not be disconnected, as PTT activation via the DATA jack does *not* enable the microphone audio path. Therefore, you will not have a "live mic" during packet operation.

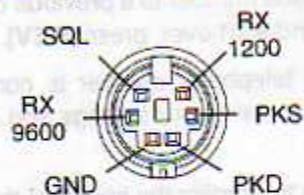

(as viewed from the rear panel)



## Cross-Band Repeater Operation

The FT-8000R can be set up to operate as a full-featured cross-band repeater with a simple power-on procedure. This feature is useful for emergency portable work in a remote area, and for cross-band linking. However, remember these points before using the cross-band repeater function:

- Check the amateur radio rules and regulations for your country to ensure that this type of operation is permitted.
- Pick your frequency pair carefully, so as not to cause harmful interference to other users. The use of cross-band repeaters has the potential to cause serious disruption of communications circuits, and the creation of harmful interference to coordinated repeaters is inconsiderate and may be illegal! If you are not sure of active repeater frequencies in your area, a safe rule is to stay off of the repeater sub-bands and use the FM simplex portion of each band. **Contact your area's frequency coordinator for guidance.**
- Remember that the transmit duty cycle will be much higher during repeater service, so we recommend that the transmit power level be set to Low, to ensure cooler operation.

Transceiver CTCSS settings (Encode/Decode) may, of course, be selected for each band, allowing selective calling for your repeater. However, keep in mind

that if the channels you use are so busy as to motivate you toward CTCSS Decoding, you may not have chosen a good frequency pair on which to operate, as the potential for interference to other users is high.

Here is the procedure for setting up cross-band repeat operation:

- Before enabling cross-band repeater operation, configure both channel settings as desired, and set the squelch such that background noise is silenced. See the pictorial for a typical example. Now turn the transceiver off.
- With the transceiver turned *off*, push and hold in the [RPT] key while turning the transceiver on. Now release the [RPT] key. The transceiver is now active in the cross-band repeater mode of operation.



- For cross-band repeat, you do not need to select a channel to be the "Main" channel, as this will change depending on which channel the input signal is received. The "▲" icon automatically switches to show which side of the FT-8000R is

transmitting, or you can glance at the LEDs by the Volume knobs to determine transceiver status.

- To exit the cross-band repeater mode, turn the transceiver off when it is not transmitting. Then push and hold in the [RPT] key while turning the transceiver on. The FT-8000R will now come on in the "normal" (non-repeater) mode of operation.

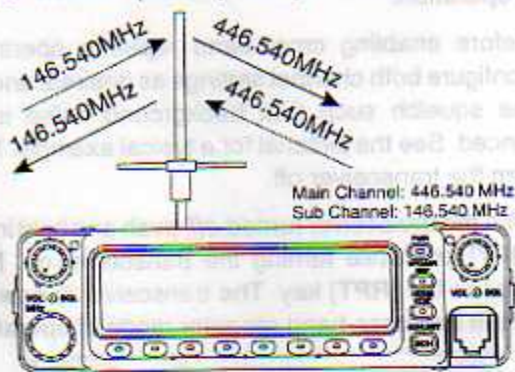

**Cross Band Repeater**

The FT-8000R can also function as a "range extender" for a hand-held transceiver in a "one-way repeat" mode. This is useful particularly on repeaters with uplinks on more than one band, and where your hand-held's antenna is not sufficient to gain access to the repeater (but where your mobile or base station's antenna *is* adequate).

- Before enabling one-way repeater operation, set the two frequencies as desired. The Main band

(with the "▲" icon displayed) will be the *downlink* (transmit) channel, while the Sub band will be the receive channel.

- With the transceiver *off*, press and hold in the [RPT] and [CNTL] keys while turning the transceiver on. One-way repeat operation is now engaged. Repeat this procedure to disable one-way repeat operation, remembering to hold in *both* the [RPT] and [CNTL] keys when so doing.

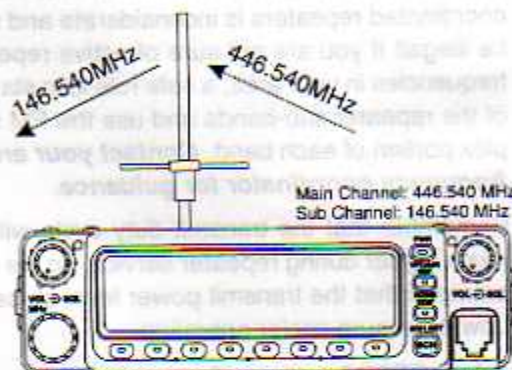

**One-Way Cross Band Repeater**

## Time-Out Timer

The "Time-Out Timer" (TOT) feature is designed to force the FT-8000R into the "receive" mode after a preset time period of continuous transmission (the default is 3 minutes). This feature prevents your FT-8000R from transmitting a "dead carrier" for a long period of time in the event that the microphone PTT switch is accidentally locked in the "TX" condition (by being wedged inadvertently between the seats in your car, for example).

The Time-Out Timer's "switch-to-receive" time may be adjusted, in one minute increments, for any period between 1 and 60 minutes. To change the default (3 minute) time setting:

- Press and hold in the [F/W] key for ½ second, then press [MUTE]. The right side of the LCD will now indicate the current "switch-to-receive" time interval.
- Rotate the Main Dial (or press the microphone's [UP] or [DWN] keys) to select a new time interval, or "Off".
- Press [MUTE] again to save the new setting and exit to normal operation.

Because the TOT feature is so useful in preventing inconvenience to other users, we strongly urge you not to disable it.

## Automatic Power-Off (APO)

The Automatic Power Off (APO) feature will turn the FT-8000R completely *off* after a user-defined period of PTT or key/button inactivity. If you do not press any front panel keys or buttons, rotate the Main Dial or use the microphone's [UP] or [DWN] keys, or transmit, and so long as the transceiver is not scanning or engaged in priority monitoring, the FT-8000R will shut itself off after the specified time period. This feature is useful in minimizing battery drain in a mobile installation if you forget to turn the transceiver off when you leave your vehicle.

To activate the APO feature:

- Press and hold in the [F/W] key for ½ second, then press the Main Dial momentarily. The "O" icon will become illuminated, if it is not already.
- Rotate the Main Dial, or press the microphone's [UP] or [DWN] keys, to select a new "switch-off" time for the APO timer. You may also select "Off" to disable the APO feature.
- Press the Main Dial momentarily to save your new setting and exit to normal operation.

**Automatic Power-Off (APO)**

The Automatic Power Off (APO) feature will turn the FT-8000R completely off after a user-defined period of PTT or keyfaster activity. If you do not press any front panel keys or buttons, rotate the Main Dial or use the microphone's [UP] or [DWN] keys, or any or engaged is properly monitoring the FT-8000R will shut off after the specified time period. This feature is useful in minimizing battery drain in a mobile installation if you forget to turn the transceiver off when you leave your vehicle.

To activate the APO feature:

- Press and hold in the [FW] key for 2 seconds, then press the Main-Dial momentarily. The LCD icon will become illuminated. If it is not already.
- Rotate the Main Dial, or press the microphone's [UP] or [DWN] keys, to select a new "switch-off" time for the APO timer. You may also select "Off" to disable the APO feature.
- Press the Main Dial momentarily to save your new setting and exit to normal operation.

**Time-Out Timer**

The Time-Out Timer (TOT) feature is designed to force the FT-8000R into the "receive" mode after a preset time period of continuous transmission (the default is 2 minutes). This feature prevents you from transmitting a "dead airnet" for a long period of time in the event that the microphone PTT switch is accidentally locked in the "TX" condition (by being wedged inadvertently between the keys in your car, for example).

The Time-Out Timer's "switch-to-receive" time may be adjusted in one-minute increments for any period between 1 and 99 minutes. To change the default 2-minute time setting:

- Press and hold in the [FW] key for 2 seconds, then press [MUTE]. The right side of the LCD will now display the current "switch-to-receive" time interval.
- Rotate the Main Dial (or press the microphone's [UP] or [DWN] keys) to select a new time interval or "Off".
- Press [MUTE] again to save the new setting and exit to normal operation.

Because the TOT feature is so useful in preventing a convenience to other users, we strongly urge you not to disable it.

# Appendix

## Power-On Settings

Some transceiver default operational settings can be enabled or disabled, changed, or reset using a power-on initialization procedure. This procedure requires you to hold a particular key (or keys) depressed while turning the transceiver, as outlined in the table below. For detailed explanations on how these affect transceiver operation, refer to the pages listed in the far right column of the chart below.

### Power-On Settings and Functions

Press and hold in the following key(s) while turning the transceiver on:	Operational Effect or Setting Enabled	Ref. Page
[VFO/MR] + [REV]	Reset transceiver CPU and all operational settings to factory defaults.	60
[F/W]	Enables Transceiver Cloning Mode.	21
[RPT]	Enables Cross-Band Repeater Mode.	55
[CNTL] + [RPT]	Enables One-Way Cross-Band Repeater Mode.	56
[TONE]	Changes Key Beeper to DTMF tones.	26
[SCH]	Enables Demonstration Mode.	-
[Right Volume Knob]	Enables DC Voltage Display Mode (During Single-Band Operation).	30
[HOME]	Toggle DTMF Auto-Dial Speed	53



## In Case of Problems

The ease of operation of the FT-8000R means that there are few ways in which you can get "lost" in programming the transceiver. This section will, however, help guide you "out of the woods" if you get stuck while learning the capabilities of your FT-8000R.

- If the transceiver will not turn on, check the power supply's on/off switch, as well as the DC cable and its fuses.
- If two beeps sound and the "ERR" icon replaces the frequency display when you attempt to transmit, you may be attempting to transmit outside of the authorized Amateur band for your country. This sometimes happens if you have manually activated a repeater shift while operating near a band edge, or if you have engaged an "odd" split or have changed the default shift. Press [RPT], as needed, to cancel all repeater shifts.
- Invalid key entries generally do nothing, and no beep will sound. However, if the front panel keys do not respond to your commands, look for the small "TTU" icon on the display, which indicates that the



Key Lock feature has been activated. Press [F/W] ⇒ [LOW] to recover.

- If pushing the PTT switch on the microphone does not cause transmission to occur, look for a small "★" icon blinking to the right of the Main band's frequency display. The star indicates that the PTT Lock feature is active. Press and hold in [F/W] for ½ second, then press [LOCK], to recover.
- If you observe that commands are not being accepted from the keys, and that the Main band's LED indicator is glowing Red (instead of Green), this indicates that you are somehow locked in the "transmit" mode. Disconnect the microphone and/or any packet cables which are connected to the transceiver, so as to determine if the PTT line is shorted to ground in one of these cables.

## Resetting the CPU

As a last resort, if you are unable to gain control of the transceiver, the FT-8000R can be reset from the keypad to clear all settings, memories, channel step changes, and odd repeater shifts; these will be reset to their factory defaults, and the transceiver's microprocessor will be returned to a "cold start" condition. A CPU reset is sometimes necessary if the transceiver has been subjected to a static discharge or other unusual condition which may have caused a voltage "spike" to "confuse" the microprocessor.

To reset the microprocessor, press and hold in the [VFO/MR] and [REV] keys while you push the [PWR] key to turn on the transceiver ([REV] is the second key from the left in the row of keys just below the LCD).



## Memory Backup

A lithium battery inside the transceiver retains all settings and memories when the transceiver's power is turned off and/or when the DC supply voltage is turned off. The backup battery's expected lifetime is in excess of five years; if and when it needs replacing, the transceiver will be found to have lost its memories (when you switch it on), although it otherwise will still operate properly.

The backup battery is on the inside of the front panel, and is not easy to access. We therefore recommend that it be replaced only by a Yaesu-authorized technician, so as to ensure that the replacement is installed properly.

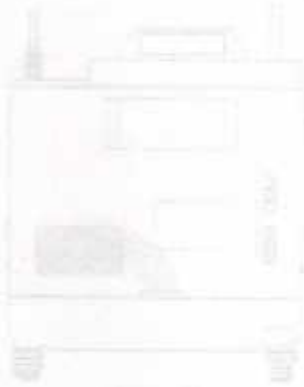

Figure 3



Downloaded by  
RadioAmateur.EU

## FTS-22 Installation

The FTS-22 includes dual CTCSS decoders for 39 user-selectable EIA standard subaudible tones. The FTS-22 provides silent monitoring of busy channels when activated in the Encode/Decode mode, and it also enables the CTCSS Bell feature. See the "Operation" chapter for more details regarding operation when the FTS-22 is operational.

Installation of the FTS-22 requires only a small Phillips screwdriver. Proceed as follows:

- Disconnect all cables and the microphone, and turn the transceiver upside-down. Referring to Figure 1, remove the six screws affixing the bottom cover.

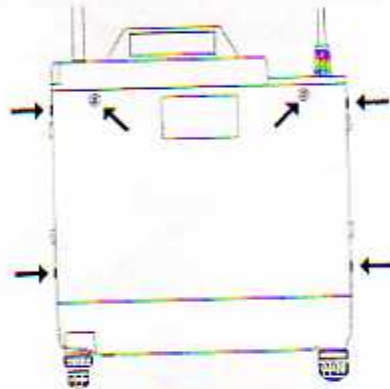

Figure 1

- Referring to Figure 2, locate the unused 12-pin connector just inside the front panel. Plug the FTS-22's cable into the connector.
- Peel the covering from one side of the double-sided tape provided with the FTS-22, and stick it in the bare area designated in Figure 2 as the "FTS-22 Mounting Location."
- The factory adjusts the output tone level (VR1 on the FTS-22) for the proper deviation, so it should require no further adjustment unless your repeater has special requirements.
- Replace the six screws to affix the bottom cover. Installation is now complete.

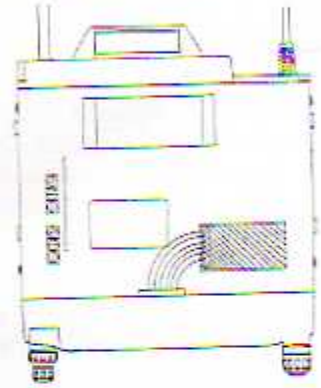

Figure 2



# Internal Adjustments

- Connect an external voltmeter to the [V] and black leads of the DC cable.
- Turn the transceiver off.
- Next, press and hold in the [REV] and [LOW] keys while you turn the transceiver on; you will observe the DC voltage on the Main display side.



- Now rotate the Main Dial so as to open the voltage on the LCD with the voltage measured on the external voltmeter. When the two readings are in agreement, press [LOW] to save your calibration and exit to normal operation.

Although the FT-8000R has been carefully aligned and tested at the factory prior to shipment, the following data may provide location information regarding key alignment points for the transceiver. We recommend that any adjustments only be performed by a qualified technician.

For detailed service information and part location data, consult the FT-8000R Technical Supplement, a comprehensive service manual which is available from your Yaesu dealer.

## LCD DC Voltmeter Alignment

If you perform a "Hard Reset" of the transceiver's CPU, the calibration of your voltage display will be lost. To re-establish the factory-calibrated value, follow the following steps:





1. Changes or modifications to this device not expressly approved by VERTEX STANDARD could void the user's authorization to operate this device.
2. This device complies with part 15 of the FCC Rules. Operation is subject to the following two conditions: (1) this device may not cause harmful interference, and (2) this device must accept any interference including interference that may cause undesired operation.
3. The scanning receiver in this equipment is incapable of tuning, or readily being altered, by the User to operate within the frequency bands allocated to the Domestic public Cellular Telecommunications Service in Part 22.

This device complies with RSS-210 of Industry Canada. Operation is subject to the following two conditions: (1) this device may not cause interference; and (2) this device must accept any interference, including interference that may cause undesirable operation of this device.

VERTX STANDARD CO. LTD.  
VERTX STANDARD  
YAESU EUROPE B.V.  
YAESU INC. LTD.  
VERTX STANDARD INC. LTD.



**VERTEX STANDARD CO., LTD.**  
4-8-8 Nakameguro, Meguro-Ku, Tokyo 153-8544, Japan

**VERTEX STANDARD**  
US Headquarters  
10900 Walker Street, Cypress, CA 90630, U.S.A.

**YAESU EUROPE B.V.**  
P.O. Box 75526, 1118 ZN Schiphol, The Netherlands

**YAESU UK LTD.**  
Unit 12, Sun Valley Business Park, Winnall Close  
Winchester, Hampshire, SO23 0LB, U.K.

**VERTEX STANDARD HK LTD.**  
Unit 5, 20/F., Seaview Centre, 139-141 Hoi Sun Road,  
Kwun Tong, Kowloon, Hong Kong

Copyright 2003  
**VERTEX STANDARD CO., LTD.**  
All rights reserved

No portion of this manual  
may be reproduced without  
the permission of  
**VERTEX STANDARD CO., LTD.**

Printed in Japan.

E06481001